



OPERATORS MANUAL

FOR

6540 SERIES

Dual Measurement High Resistance Bridge

NOTICE

The contents and information contained in this manual are proprietary to Guildline Instruments Limited. They are to be used only as a guide to the operation and maintenance of the equipment with which this manual was issued and may not be duplicated or transmitted by any means, either in whole or in part, without the written permission of Guildline Instruments Limited.

OM6540-C5-00
4 April, 2024

TABLE OF CONTENTS

1. INTRODUCTION.....	1-1
1.1. FUNCTION DESCRIPTION	1-1
1.1.1. PHYSICAL DESCRIPTION	1-2
1.1.2. PRINCIPLE OF OPERATION.....	1-3
1.1.3. MODES OF OPERATION.....	1-4
1.1.4. CIRCUIT DISCUSSION.....	1-5
2. INSTALLATION.....	2-1
2.1. INSTALLATION	2-1
2.2. PRELIMINARIES	2-1
2.3. PRECAUTIONS	2-3
2.4. CONTROLS AND INDICATORS.....	2-3
2.4.1. SWITCH FUNCTIONS.....	2-4
2.4.1.1. Rear Panel POWER Entry.....	2-4
2.4.1.2. Front Panel KEYPAD	2-4
2.4.1.3. Front Panel Menu Navigation Keys	2-4
2.4.1.4. Front Panel Programmable Function Keys.....	2-4
2.4.2. DISPLAY	2-4
2.4.3. CONNECTORS.....	2-5
2.4.3.1. SOURCE CONNECTORS.....	2-5
2.4.3.2. INPUT CONNECTOR.....	2-6
2.4.4. REAR PANEL CONTROLS.....	2-7
2.4.4.1. IEEE-488 INTERFACE	2-7
2.4.4.2. RS232 INTERFACE	2-7
2.4.4.3. Ground Terminal.....	2-7
2.4.4.4. LINE INPUT CONNECTOR.....	2-8
2.4.4.5. EXTERNAL TRIGGER CONNECTOR	2-8
2.4.4.6. INTERLOCK CONNECTOR.....	2-8
3. QUICK MEASUREMENT GUIDE	3-1
3.1. RESISTANCE MEASUREMENT.....	3-1
3.1.1. DIRECT RESISTANCE MEASUREMENT PROCEDURE.....	3-1
3.1.2. 2-TERMINAL RESISTANCE CONNECTION SCHEMATIC.....	3-2
3.1.3. 3-TERMINAL RESISTANCE CONNECTION SCHEMATIC.....	3-3
3.2. BRIDGE VS DIRECT MEASUREMENT	3-4
3.3. CURRENT MEASUREMENT.....	3-6
3.3.1. CURRENT MEASUREMENT PROCEDURE.....	3-6
3.3.2. CURRENT SOURCE CONNECTION SCHEMATIC	3-7

4.	INSTRUMENT OPERATION	4-1
4.1.	BASIC MENU OPERATION.....	4-1
4.1.1.	Menu System	4-1
4.1.2.	Key functions.....	4-2
4.1.2.1.	Navigation keys (up/down, left/right arrow)	4-2
4.1.3.	Select Mode	4-3
4.1.4.	Edit Mode	4-4
4.2.	MAIN MENU.....	4-4
4.3.	Measurement Menu.....	4-6
4.4.	Ohms Measurement Menu	4-6
4.4.1.	Ohms Setup.....	4-8
4.4.2.	Ohms Parameters Menu.....	4-10
4.4.3.	RESISTANCE, MANUAL RANGING	4-11
4.4.4.	Control Menu.....	4-13
4.4.5.	Trace	4-13
4.4.6.	Timers	4-14
4.4.7.	Polarity.....	4-14
4.4.8.	Profiles	4-14
4.4.9.	View.....	4-16
4.4.9.1.	Summary	4-16
4.4.9.2.	Detail	4-17
4.5.	Current - MEASURING PICOAMPERES.....	4-17
4.5.1.	AUTO-RANGING - Current	4-18
4.5.2.	MANUAL RANGING - Current.....	4-18
4.6.	Surface Resistivity	4-20
4.7.	Volume Resistivity	4-21
4.7.1.	Volume Resistivity Thickness Setup	4-21
4.7.2.	Volume Resistivity Configure	4-21
4.8.	Configure.....	4-22
4.8.1.	GPIB	4-22
4.8.2.	RS232	4-23
4.8.3.	Fixture.....	4-24
4.8.4.	Sys Time	4-24
4.9.	Sofcal.....	4-25
4.9.1.	User.....	4-26
4.9.1.1.	Calibration Coefficients	4-26
4.9.1.2.	Self Test	4-27
4.9.2.	Calibrate.....	4-28
4.9.2.1.	Utilities.....	4-28
4.9.2.2.	Calibration Coefficient Values.....	4-33
4.9.2.3.	Reference Values.....	4-37

4.9.3.	Diagnostics	4-41
4.9.3.1.	Digital PS	4-42
4.9.3.2.	Analog PS.....	4-42
4.9.3.3.	Relay Test.....	4-42
4.9.3.4.	Voltage Test	4-43
4.9.3.5.	External Input.....	4-43
4.9.3.6.	DAC7548 Calibrate.....	4-44
4.9.4.	Password.....	4-44
4.10.	Menu System Hierarchy Diagrams.....	4-45
5.	REMOTE CONTROL.....	5-1
5.1.	INTERFACES.....	5-1
5.2.	IEEE-488 (GPIB) INTERFACE.....	5-1
5.2.1.	CONTROLLER.....	5-2
5.2.2.	IEEE-488 RESPONSES	5-2
5.2.3.	INTERCONNECTING CABLE AND IEEE-488 CONNECTOR.....	5-2
5.2.4.	TYPICAL SYSTEM.....	5-2
5.2.5.	ADDRESS AND TALK/LISTEN SELECTION.....	5-3
5.2.6.	IEEE-488 ELECTRICAL INTERFACE	5-3
5.2.7.	IEEE-488 INPUT BUFFERING.....	5-4
5.2.8.	IEEE-488 OUTPUT BUFFERING.....	5-4
5.2.9.	IEEE-488 DEADLOCK	5-5
5.3.	RS-232C INTERFACE.....	5-5
5.3.1.	RS-232C RESPONSES	5-6
5.4.	COMMAND LANGUAGE.....	5-6
5.4.1.	GENERAL SYNTAX FOR COMMANDS	5-6
5.4.2.	GENERAL SYNTAX FOR NUMBERS.....	5-7
5.4.3.	REMOTE AND LOCAL OPERATION.....	5-7
5.4.4.	LOCAL.....	5-7
5.4.5.	REMOTE.....	5-8
5.4.6.	REMOTE WITH LOCKOUT.....	5-8
5.5.	PROGRAMMING COMMAND SUMMARY.....	5-9
5.5.1.	Standard System Commands	5-10
5.5.2.	Calibration Commands	5-12
5.5.3.	Configuration Commands.....	5-13
5.5.4.	Measurement Commands	5-13
5.5.5.	Trace Commands.....	5-15
5.5.6.	Trigger Commands	5-16
5.6.	REMOTE COMMANDS.....	5-17
5.6.1.	*CLS - CLEAR STATUS COMMAND	5-17
5.6.2.	*ESE <u> - SET EVENT STATUS ENABLE REGISTER.....	5-17
5.6.3.	*ESE? - EVENT STATUS ENABLE QUERY	5-17
5.6.4.	*ESR? - EVENT STATUS REGISTER QUERY	5-17
5.6.5.	*IDN? - IDENTIFICATION QUERY	5-18
5.6.6.	*OPC - OPERATION COMPLETE.....	5-18
5.6.7.	*OPC? - OPERATION COMPLETE QUERY	5-18
5.6.8.	*OPT? - REPORT AVAILABLE OPTIONS.....	5-19
5.6.9.	*RST - DEVICE RESET	5-19

5.6.10.	*SRE <u>	- SERVICE REQUEST ENABLE COMMAND	5-19
5.6.11.	*SRE?	- SERVICE REQUEST ENABLE QUERY	5-19
5.6.12.	*STB?	- STATUS BYTE QUERY	5-19
5.6.13.	*TST?	- QUERY RESULTS OF SELF TEST.....	5-20
5.6.14.	*WAI	- WAIT-TO- CONTINUE COMMAND	5-21
5.6.1.	SYSTem:BRIDGE	- SET BRIDGE/DIRECT MODE	5-21
5.6.2.	SYSTem:BRIDGE?	- DISPLAY BRIDGE/DIRECT MODE	5-21
5.6.3.	SYSTem:CHECK:SUM?	- DISPLAY CHECKSUMS	5-21
5.6.4.	SYSTem:COMMunications:GPIB	- UPDATE GPIB CONFIG	5-21
5.6.5.	SYSTem:COMMunications:GPIB?	5-21
5.6.6.	SYSTem:COMMunications:SERial	5-22
5.6.7.	SYSTem:COMMunications:SERial?	5-22
5.6.8.	SYSTem:DATE	- UPDATE SYSTEM DATE	5-22
5.6.9.	SYSTem:DATE?	- DISPLAY SYSTEM DATE	5-22
5.6.10.	SYSTem:KEY?	- DISPLAY LAST KEY STROKE.....	5-22
5.6.11.	SYSTem:MODE	- SET SYSTEM MODE.....	5-22
5.6.12.	SYSTem:MODE?	- DISPLAY SYSTEM MODE	5-22
5.6.13.	SYSTem:SERial:NUMBer	- SET SYSTEM SERIAL NUMBER.....	5-23
5.6.14.	SYSTem:SERial:NUMBer?	- DISPLAY SYSTEM SERIAL NUMBER	5-23
5.6.15.	SYSTem:STATe	- UPDATE SYSTEM STATE	5-23
5.6.16.	SYSTem:STATe?	- DISPLAY SYSTEM STATE.....	5-23
5.6.17.	SYSTem:TERSe	- SET SYSTEM TO TERSE	5-24
5.6.18.	SYSTem:TIME	- SET SYSTEM TIME.....	5-24
5.6.19.	SYSTem:TIME?	- DISPLAY SYSTEM TIME	5-24
5.6.20.	SYSTem:VERSion?	- DISPLAY SYSTEM VERSION	5-24
5.6.21.	SYSTem:VERBoSe	- SET SYSTEM TO VERBOSE.....	5-24
5.6.22.	CALibration:CAPacitor	- UPDATE COEFFICIENT	5-24
5.6.23.	CALibration:CAPacitor?	- DISPLAY COEFFICIENTS	5-24
5.6.24.	CALibration:DATE	- UPDATE LAST CALIBRATION DATE	5-24
5.6.25.	CALibration:DATE?	- DISPLAY LAST CALIBRATION DATE.....	5-25
5.6.26.	CALibration:OUTPut:VOLTage	- UPDATE COEFFICIENTS	5-25
5.6.27.	CALibration:OUTPut:VOLTage?	- DISPLAY COEFFICIENTS	5-25
5.6.28.	CALibration:PARAmeters:PROTection	5-25
5.6.29.	CALibration:PARAmeters:PROTection?	5-25
5.6.30.	CALibration:PARAmeters:RESistor	5-26
5.6.31.	CALibration:PARAmeters:RESistor?	5-26
5.6.32.	CALibration:PROTection:RESistor	5-26
5.6.33.	CALibration:PROTection:RESistor?	5-26
5.6.1.	CALibrate:RATIO:COEFFicient	5-27
5.6.2.	CALibrate:RATIO:COEFFicient?	5-27
5.6.3.	CALibration:REFerence:RESistor	5-27
5.6.4.	CALibration:REFerence:RESistor?	5-27
5.6.5.	CALibration:SERial:NUMBer	5-27
5.6.6.	CALibration:SERial:NUMBer?	5-27
5.6.7.	CALibration:SPEC:CLEar	5-27
5.6.8.	CALibration:SPEC?	5-27
5.6.9.	CALibration:SYSTem:COEFFicient	5-28
5.6.10.	CALibration:SYSTem:COEFFicient?	5-28
5.6.11.	CALibration:SYSTem:PARAmeters	5-28
5.6.12.	CALibration:SYSTem:PARAmeters?	5-28
5.6.13.	CALibration:SYSTem:REV	5-28
5.6.14.	CALibration:SYSTem:REV?	5-28
5.6.15.	CALibration:THREshold:VOLTage	5-28
5.6.16.	CALibration:THREshold:VOLTage?	5-28
5.6.17.	CONFigure:TEST:VOLTage	5-28
5.6.18.	MEASure	- START/STOP MEASUREMENT.....	5-29

5.6.19.	MEASure?	5-29
5.6.1.	MEASure:KNOWN	5-29
5.6.2.	MEASure:KNOWN?	5-29
5.6.3.	MEASure:UNITS – SET CURRENT MEASUREMENT MODE	5-29
5.6.4.	MEASure:UNITS? – DISPLAY MEASUREMENT MODE	5-29
5.6.5.	READ:RESistance? – DISPLAY DIRECT READING RESISTANCE	5-29
5.6.1.	READ:VALUES? – DISPLAY BRIDGE MODE RESISTANCE	5-29
5.6.2.	READ:CURRent?	5-29
5.6.3.	READ:SURFace:RESistivity?	5-29
5.6.4.	READ:VOLume:RESistivity?	5-30
5.6.5.	SENSe:CAPacitor – SET CURRENT CAPACITOR	5-30
5.6.6.	SENSe:CAPacitor? – DISPLAY CURRENT CAPACITOR	5-30
5.6.7.	SENSe:INTEgration:TIME?	5-30
5.6.8.	SENSe:INTEGrator:THRESHold	5-30
5.6.9.	SENSe:INTEgrator:THRESHold?	5-30
5.6.10.	SENSe:MAXimum:VOLTage	5-30
5.6.11.	SENSe:MAXimum:VOLTage?	5-30
5.6.12.	SENSe:OUTput:VOLTage	5-30
5.6.13.	SENSe:OUTput:VOLTage?	5-30
5.6.14.	SENSe:POLarity	5-31
5.6.15.	SENSe:POLarity?	5-31
5.6.16.	SENSe:RANGe	5-31
5.6.17.	SENSe:RANGe?	5-31
5.6.18.	SENSe:REMote:INTErlock	5-31
5.6.19.	SENSe:REMote:INTErlock?	5-31
5.6.20.	SENSe:RESistivity:THICKness	5-31
5.6.21.	SENSe:RESistivity:THICKness?	5-31
5.6.22.	SENSe:RESistivity:AREA	5-31
5.6.23.	SENSe:RESistivity:AREA?	5-32
5.6.24.	SENSe:RESistivity:PERimeter	5-32
5.6.25.	SENSe:RESistivity:PERimeter?	5-32
5.6.26.	SENSe:RESistivity:DISTance	5-32
5.6.27.	SENSe:RESistivity:DISTance?	5-32
5.6.28.	TRACe:CLEAr – CLEAR DETAIL TRACE BUFFER	5-32
5.6.29.	TRACe:DATA? – DUMP TRACE BUFFER	5-32
5.6.30.	TRACe:DIAGnostics	5-33
5.6.31.	TRACe:DIAGnostics?	5-33
5.6.32.	TRACe:MODE	5-33
5.6.33.	TRACe:MODE?	5-33
5.6.34.	TRACe:ELEMents	5-33
5.6.35.	TRACe:ELEMents?	5-33
5.6.36.	TRACe:TREND:DATA? – DUMP SUMMARY BUFFER	5-33
5.6.37.	TRACe:TREND:SUM? - DUMP SUMMARY STATISTICS	5-33
5.6.38.	TRACe:TREND:CLEAr – CLEAR SUMMARY STATISTICS	5-33
5.6.39.	TRACe:TSTamp:TYPE	5-33
5.6.40.	TRACe:TSTamp:TYPE?	5-34
5.6.41.	TRIGger:SOURce	5-34
5.6.42.	TRIGger:SOURce?	5-34
5.6.43.	TRIGger:DELay	5-34
5.6.44.	TRIGger:DELay?	5-34
5.6.45.	TRIGger:SOAK	5-34
5.6.46.	TRIGger:SOAK?	5-34

6.	VERIFICATION AND CALIBRATION	6-1
6.1.	CALIBRATION DESCRIPTION.....	6-1
6.1.1.	ENVIRONMENTAL CONDITIONS.....	6-1
6.1.2.	INITIAL CONDITIONS	6-1
6.1.3.	RECOMMENDED TEST EQUIPMENT.....	6-1
6.1.4.	CHECK CALIBRATION REPORT.....	6-1
6.1.4.1.	CALIBRATION COEFFICIENTS	6-2
6.1.5.	TEST VOLTAGE VERIFICATION	6-2
6.1.6.	OPERATIONAL CHECK.....	6-3
6.2.	CALIBRATION PROCEDURE	6-3
6.2.1.	ENVIRONMENTAL CONDITIONS.....	6-3
6.2.2.	INITIAL CONDITIONS	6-3
6.2.3.	RECOMMENDED TEST EQUIPMENT.....	6-4
6.2.4.	OUTPUT VOLTAGE CALIBRATION.....	6-4
6.2.5.	AUTO CALIBRATION	6-5
6.2.6.	CAPACITOR CALIBRATION.....	6-6
6.2.7.	THRESHOLD CALIBRATION.....	6-8
6.2.8.	ZERO COEFFICIENT CALIBRATION.....	6-9
6.3.	CALIBRATION REPORT	6-10
6.4.	CALIBRATION THEORY	6-12
6.4.1.	Rprotection COEFFICIENT	6-12
6.4.2.	Vtest COEFFICIENTS	6-12
6.4.3.	Cintegrator COEFFICIENTS.....	6-13
6.4.4.	Tintegrator COEFFICIENTS.....	6-13
7.	TROUBLE SHOOTING AND MAINTENANCE.....	7-1
7.1.	PREVENTATIVE MAINTENANCE.....	7-1
7.2.	NON VOLATILE MEMORY CHECKSUM.....	7-2
7.3.	TROUBLESHOOTING	7-2
7.4.	ERROR MESSAGES.....	7-3
8.	APPENDICES.....	8-1
8.1.	GENERAL SPECIFICATIONS.....	8-1
8.2.	RESISTANCE MEASUREMENT SPECIFICATIONS	8-2
8.3.	PICOAMMETER MEASUREMENT SPECIFICATIONS	8-3
8.4.	RESOLUTION	8-4
8.5.	SYSTEM PARAMETER.....	8-5
8.6.	SAMPLE BUS CONTROL PROGRAM.....	8-9

8.7.	MEASUREMENT TECHNIQUE	8-12
8.7.1.	LARGE VALUE RESISTOR MEASUREMENT TECHNIQUE.....	8-12
8.7.2.	ENVIRONMENT	8-12
8.7.3.	SAMPLE PREPARATION	8-12
8.7.4.	TEST LEAD ROUTING	8-12
8.7.5.	CAPACITIVE TEST SAMPLES	8-12
8.8.	OTHER FEATURES	8-13
8.9.	ACCESSORY EQUIPMENT	8-14
8.9.1.	Surface/Volume Resistivity Test Fixture Model 65221	8-14
8.9.2.	Calibration Resistors	8-14
8.9.3.	Small Shielded Enclosure	8-16
8.9.4.	Large Shielded Enclosure	8-16
8.9.5.	Lead Set Model 65225	8-16
8.9.6.	Calibration Kit Model 65226	8-17
8.9.7.	Zero Link Model 65224	8-17
8.9.8.	IEEE Interface Accessories.....	8-17
8.9.9.	6564 High Resistance Scanner.....	8-17

LIST OF FIGURES

FIGURE 1-1: 6540 FRONT PANEL.....1-2
FIGURE 1-2: 6540 REAR PANEL1-2
FIGURE 1-3: 6540 OPERATIONAL INTEGRATOR1-6
FIGURE 2-1: OPENING THE POWER RECEPTACLE2-2
FIGURE 2-2: 6540 FRONT PANEL.....2-4
FIGURE 2-3: 6540 FRONT PANEL CONNECTORS – DIRECT MODE2-5
FIGURE 2-4: 6540 REAR PANEL CONNECTORS2-7
FIGURE 2-5: TYPICAL EXTERNAL TRIGGER CIRCUITS.....2-8
FIGURE 2-6: TYPICAL INTERLOCK CIRCUIT CONFIGURATION2-9
FIGURE 3-1: 2-TERMINAL RESISTANCE MEASUREMENT SCHEMATIC3-2
FIGURE 3-2: 3-TERMINAL RESISTANCE MEASUREMENT SCHEMATIC3-3
FIGURE 3-3: CURRENT SOURCE MEASUREMENT SCHEMATIC.....3-7
FIGURE 4-1: OHMS HIERARCHY4-46
FIGURE 4-2: CURRENT HIERARCHY.....4-47
FIGURE 4-3: RESISTIVITY HIERARCHY.....4-48
FIGURE 4-4: SETUP HIERARCHY4-49
FIGURE 4-5: SOFCAL HIERARCHY4-50
FIGURE 4-6: SOFCAL CAL. VALS. HIERARCHY4-51
FIGURE 4-7: SOFCAL DIAGNOSTIC HIERARCHY.....4-52
FIGURE 5-1 : EVENT STATUS BIT OPERATION5-16

LIST OF TABLES

TABLE 2-1: POWER FUSE SELECTION	2-2
TABLE 5-1 : IEEE-488 DEVICE CAPABILITIES	5-3
TABLE 5-2 : IEEE-488 PIN DESIGNATIONS	5-4
TABLE 5-3 : RS232 PIN DESIGNATIONS	5-5
TABLE 5-4 : REMOTE/LOCAL STATE TRANSITIONS	5-8
TABLE 5-5 : EVENT STATUS REGISTER	5-18
TABLE 5-6 : STATUS BYTE REGISTER	5-20
TABLE 6-1: RECOMMENDED VERIFICATION TEST EQUIPMENT	6-1
TABLE 6-2: RECOMMENDED CALIBRATION TEST EQUIPMENT	6-4
TABLE 6-3: SAMPLE CALIBRATION REPORT FORMAT	6-11
TABLE 8-1: GENERAL SPECIFICATIONS	8-1
TABLE 8-2: BRIDGE MODE RESISTANCE MEASUREMENT UNCERTAINTY	8-2
TABLE 8-3: DIRECT RESISTANCE MEASUREMENT UNCERTAINTY	8-3
TABLE 8-4: CURRENT MEASUREMENT UNCERTAINTY (ALL MODELS)	8-3
TABLE 8-5: MEASUREMENT RESOLUTIONS (DIGITS)	8-4
TABLE 8-6: DEFAULT SYSTEM PARAMETER	8-9
TABLE 8-7: CALIBRATION RESISTORS	8-15
TABLE 8-8: IEEE INTERFACES	8-17

1. INTRODUCTION

This manual provides information on the installation and operation of the Guildline Instruments Model 6540 Dual Measurement High Resistance Bridge. Also included is a general description of the theory of operation.

1.1. FUNCTION DESCRIPTION

The Guildline Model 6540 Dual Measurement High Resistance Bridge is a microprocessor based, fully automated, high precision device for measuring high value DC. It combines the proven technology of previous Guildline Teraohmmeters (i.e. Models 9520, 6500, 6520 and 6530) with the latest in measurement circuitry mounted in a temperature controlled chamber for superior stability. In bridge mode, fully automated measurements can be made using a known reference resistance standard and an unknown resistance of the same or different nominal value.



The main features of the 6540 Dual Measurement High Resistance Bridge are:

- Lowest uncertainty of any commercial high resistance measurement instrument
- Automated Direct measurement reading operation
- Automated Bridge measurement allowing transfers from reference artifacts
- Temperature controlled chamber for all measurement circuitry
- Auto ranging of resistance from 90 k Ω to 20 P Ω , including automated setting of measurement parameters
- Auto ranging of current from 10 μ A to 100 fA, including automated setting of measurement parameters
- Built in GPIB and RS-232C interfaces
- Fully controllable through the bus interfaces and SCPI commands
- Extensive self-diagnostics
- User-friendly interface



Figure 1-1: 6540 Front Panel



Figure 1-2: 6540 Rear Panel

1.1.1. PHYSICAL DESCRIPTION

The Guildline 6540 Dual Measurement High Resistance Bridge is housed in a steel case for reduction of electromagnetic emissions in compliance with CE standards, and to protect the measurement circuitry from EMI. All indicators and frequently used controls are located on the front panel together with four connectors for connection of the known resistor and unknown resistor, or a current source. The power connection is made through a detachable 3-conductor power cord, which plugs into the rear panel. The instrument has reversible measurement connections for use with supplied front panel flanges to allow it to be mounted in a standard 19-inch cabinet.

1.1.2. PRINCIPLE OF OPERATION

When measuring resistance, a known DC test voltage is supplied by the 6540, which causes a current to flow through the resistor into an integrator. The magnitude of this current is determined by the time required for the integrator output to pass between two different threshold voltage points. Knowing the test voltage and magnitude of the current, the microprocessor can determine the value of the resistor. The test voltage is selectable from 10 standard values in the range $\pm (1 \text{ to } 1000) \text{ DC V}$. The standard values are: $\pm 1 \text{ V}$, 2 V , 5 V , 10 V , 20 V , 50 V , 100 V , 200 V , 500 V , and 1000 V DC .

In Direct Mode a single voltage source is connected to the resistor being measured (i.e. R_x). In Bridge Mode the same voltage source is used for the reference resistor (i.e. R_s) and the unknown resistance (i.e. R_x).

With the Current option, unknown currents can be measured by connecting the unknown current source output directly to the integrator input (the internal voltage source is not used when measuring currents).

The stability of the Model 6540 depends on the stability of the applied test voltage, the integrator, the timing circuit and the threshold voltage detector at the integrator output. This is achieved by housing these circuits in a tightly controlled temperature chamber within the instrument. The internal temperature chamber is designed to also provide EMI protection. The fixed deviations in the absolute values of these parameters are compensated during calibration by using a software calibration routine in conjunction with a set of external calibration resistors of known value. Guildline manufactures 9336 and 9337 calibration resistors that are ideally suited for this purpose. Guildline also manufactures a 6636 Temperature Stabilized Resistor set that is suited to calibrate the 6540 in environments where the temperature is not regulated to laboratory standards.

The Model 6540 is fully automated with an internal microprocessor to compute the measurements and make the deviation compensations. The microprocessor can be operated from the front panel manual controls or from either one of the two communication control buses. In Direct measurement mode the calculated value of the unknown resistor is displayed on the front panel and is made available to instruments attached to either control bus. In Bridge mode the ratio of the reference resistor to the unknown resistor can be displayed. The Model 6540 provides increased accuracy through integrated filtering options and taking measurements with test voltage polarity alterations. The computed average is displayed on the front panel and is made available to instruments on the control bus (GPIB or RS-232C).

1.1.3. MODES OF OPERATION

The Model 6540 has two modes of operation.

Direct mode for Rx is fully automated for simplicity and convenience. Autoranging is provided to automate the measurement setup including setting the measurement parameters. When specific measurement parameters are required the operator (or instruments on the control bus) can manually configure the 6540.

Bridge mode is fully automated to use the Rs value (i.e. reference resistance standard) to calibrate (i.e. determine the error) the Rx value. Measurement parameters in Bridge mode are selected by the Auto Range feature only to ensure that both the Rs and Rx are measured the same way. In bridge mode resistance ratio Rr is calculated with the average value of Rx divided by the average value of Rs. Rx corrected or Rxc is calculated by multiplying Rr by Rs known, where Rs known is previously entered. In Bridge mode Rxc or Rr can be displayed.

The instrument can be set to take a continuous series of measurements or to take one measurement for each sample request. A sample request can be made with an external synchronizing signal fed to a rear panel connector or by the operator pressing a front panel function key/push-button.

The number of resistance measurements made per data sample output (averaged), is user selectable. The resistance test voltage polarity is selectable. When measuring current, both polarities can also be accommodated by this selection.

The SOFCAL (software calibration) function permits the operator to calibrate the instrument and edit the calibration date and the serial number of the instrument.

1.1.4. CIRCUIT DISCUSSION

The Model 6540 Dual Measurement High Resistance Bridge measures high values of resistance by charging a small capacitor through the resistance to be measured. An operational integrator is shown in Figure 1-3. The equations for this integrator are as follows:

$$\frac{\Delta V_{out}(t)}{\Delta t} = \frac{V_{in}}{R \times C} \quad \begin{array}{l} \text{(The equality is not exact} \\ \text{but is extremely close when} \\ \text{the voltage gain is high)} \end{array} \quad (1)$$

or:

$$R = \frac{V_{in} \times \Delta t}{C \times \Delta V_{out}} \quad (2)$$

Where Δt = a change in time and ΔV_{out} = a change in output voltage V_{out} over time Δt .

When current is being measured, V_{in} can be replaced by iR which simplifies (1) to the form:

$$i = \frac{C \times \Delta V_{out}}{\Delta t} \quad (3)$$

In the Model 6540:

- * V_{in} is the test voltage for resistance measurement.
- * C is a stable capacitor selected from the nominal values of 27 pF, 270 pF or 2700 pF.
- * ΔV_{out} is the potential difference between two threshold voltages placed symmetrically above and below ground ($V_{out} = 2V_{thresh}$ where V_{thresh} is selectable from 0.1 volt, 1 volt or 10 volts).

In equations (2) and (3), all terms are constant except R , i and Δt . Therefore Δt is proportional to R or inversely proportional to the current i . During normal operation the 6540 calculates the unknown resistance R or current i by taking measurements of the Δt time.

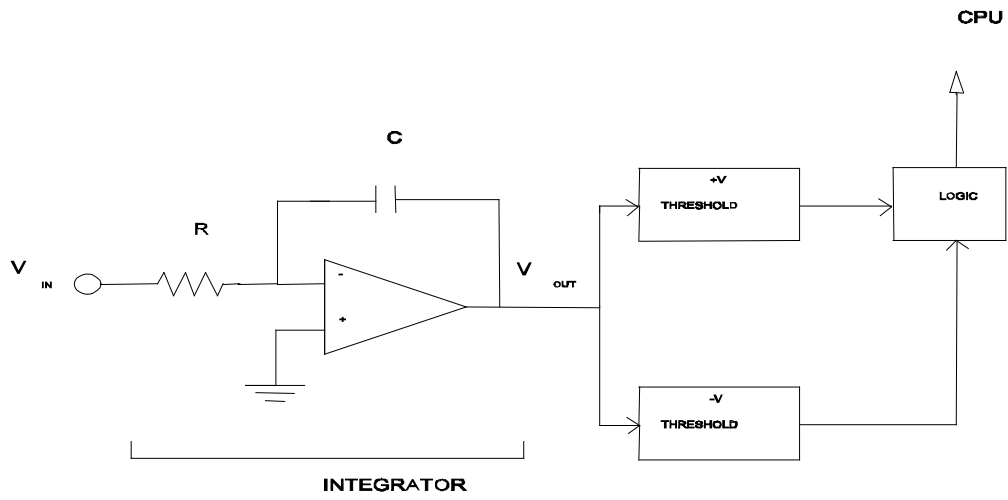

Figure 1-3: 6540 Operational Integrator

2. INSTALLATION

2.1. INSTALLATION

This instrument was thoroughly tested and inspected before shipment and should be free from damage when received. Inspect it carefully, verify that all items on the packing list are present and check the instrument operation as soon as possible. Refer to the warranty card at the front of this manual if any damage or deficiencies are found.

The 6540 Dual Measurement High Resistance Bridge is an instrument intended to be used in a laboratory environment and is specified to be operated within an environmental temperature range of $23\text{ }^{\circ}\text{C} \pm 5\text{ }^{\circ}\text{C}$ with humidity levels in the range of 20 % to 50 % rH. Optimum performance is achieved when the environmental temperature range is $(23 \pm 2)\text{ }^{\circ}\text{C}$. Higher humidity can degrade the accuracy of the instrument. The 6540 must be mounted with an angle of inclination of no more than 30° . To attach the rack mounting flanges (brackets), the original screws holding the handles to the instrument are removed and the flanges attached over the handles with the longer screws supplied. The instrument has to be supported in the rack/cabinet with adjustable support angles or a support bar. In case of interference with other equipment mounted directly below the instrument, the 4 feet must be removed.

2.2. PRELIMINARIES

The Model 6540 has been shipped with the line input voltage set to 240 volts with the fuse removed. The line input selectors must be set to the correct line voltage before power is applied to the instrument. Remove the warning label positioned across the power entry only after setting the proper operating voltage. The line input voltage selection must be set correctly. The settings available are 100 V, 120 V, 220 V, and 240 V. Figure 2-1 details the line input voltage selector.

The instrument is supplied with a North American style line cord, unless otherwise specified at time of order. Ensure that the line cord is plugged into a wall socket or extension cord that has a protective or safety ground. Where 3-contact power supply outputs are not available, a suitable protective ground connection must be made before switching the instrument power on. Any interruption of the protective ground may possibly render the instrument unsafe.

To set the correct line input voltage pry open the power receptacle on the rear panel as shown in Figure 2-1.

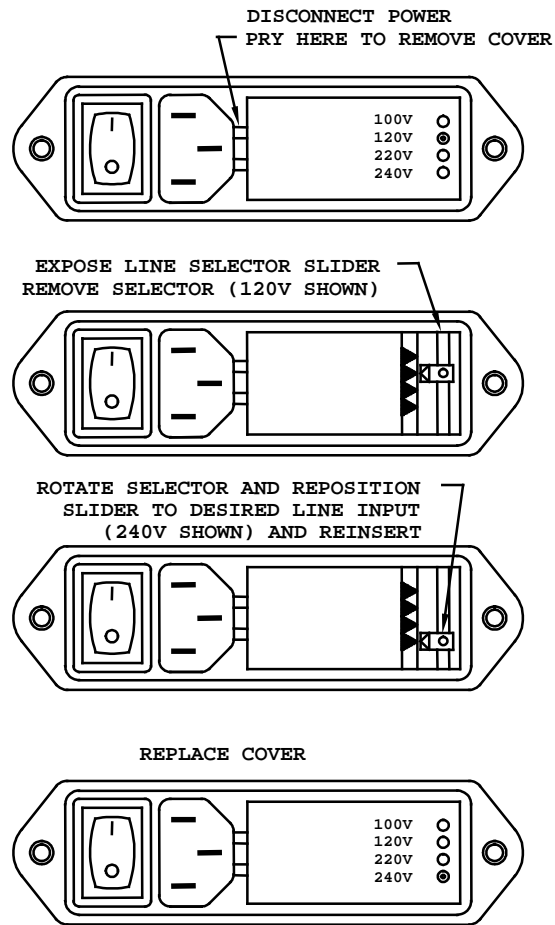

Figure 2-1: Opening the Power Receptacle

Check to see that the fuses inserted in the receptacle correspond to the correct type specified in Table 2-1.

Line Voltage	Fuse Type Required
100 V 120 V	2 Amp (T) (MDL_2A/250 V)
220 V 240 V	1 Amp (T) (MDL-1A/250 V)

Table 2-1: POWER FUSE SELECTION

Only fuses of the specified type are to be used. Set the voltage selector drum so that the proper line voltage indication will be visible through the receptacle rear window when the receptacle

cover is closed. This is important because the drum selects the proper transformer connection for the required voltage.

The supplied molded line cord should be plugged into the 3 pin power receptacle on the rear panel of the instrument. Plug the line cord into a receptacle with the required voltage and a protective ground connection.

Where the molded plug on the supplied line cord does not match the power outlet receptacle the plug may be removed and replaced with a 3-pin plug of the correct type.

The plug should be wired as follows:

Brown	-	Line voltage
Blue	-	Neutral
Green/Yellow	-	Ground (Earth)

2.3. PRECAUTIONS

The instrument should be disconnected from the line supply before any attempt is made to remove the cover. Lethal voltages are present at several points within the instrument and under some operating conditions at the source connector. **Therefore, ONLY QUALIFIED PERSONNEL WHO ARE AWARE OF THE NECESSARY PRECAUTIONS SHOULD BE GIVEN ACCESS TO THIS EQUIPMENT.**

Operation of the instrument with the cover removed will result in degraded performance due to the lack of shielding from radiated electrical interference.

2.4. CONTROLS AND INDICATORS

The front panel of the 6540 Dual Measurement High Resistance Bridge, as shown in Figure 2-2, has a prominent 256 by 64 dot vacuum fluorescent graphic display, which provides a visual readout of data and status. Four momentary action programmable function keys located below the display window combine to provide complete user control and functionality of the 6540. A conventional 3 column by 5 row keypad matrix provides user entry of the digits 0,1,2,3,4,5,6,7,8,9,-, and (.). In addition, a set of keys labelled "CLEAR", "E", "LOAD", with cursor movement keys Up Arrow, Down Arrow, Left Arrow, Right Arrow and menu control keys "PREVIOUS" and "CANCEL", allow for operator navigation through the set-up and operation of the 6540.



Figure 2-2: 6540 Front Panel

2.4.1. SWITCH FUNCTIONS

2.4.1.1. Rear Panel POWER Entry

The on/off toggle switch is the only function that cannot be controlled by the GPIB and RS-232C bus interfaces.

2.4.1.2. Front Panel KEYPAD

The keypad consists of a 3 key by 5 key momentary switch arrangement that allows entry of a numeric sequence (0, 1, 2, 3, 4, 5, 6, 7, 8, 9). Additional keys in the keypad layout allow for the selection of decimal point “.”, minus “-”, “CLEAR”, exponent “E” and “LOAD” functions

2.4.1.3. Front Panel Menu Navigation Keys

Two momentary action keys labeled “PREVIOUS” and “CANCEL” allow the operator to move between menu levels of the 6540.

2.4.1.4. Front Panel Programmable Function Keys

This series of four momentary action keys allow for the selection of any one of 4 software-controlled actions. The action available for each function key is displayed in the display directly above the key.

2.4.2. DISPLAY

The main graphic display that shows the measured data and provides system level information to the operator during the measurement cycle(s), as well as the software calibration and system initialization procedures.

2.4.3. CONNECTORS

Four connectors are mounted to the front panel for attachment of the R_s and R_x resistances or current under test (see Figure 2-3 6540 Front Panel Terminals). The connectors are labeled “SOURCE” and “INPUT” for both “Rs” and “Rx”.



Figure 2-3: 6540 Front Panel Connectors – Direct Mode

2.4.3.1. SOURCE CONNECTORS

Lethal voltages of up to 1000 volts may be present at these outputs and appropriate precautionary measures are necessary. **UNQUALIFIED OR UNINFORMED PERSONNEL SHOULD NOT BE GIVEN ACCESS TO THIS EQUIPMENT.**

The selected voltage is present at the center conductor of the high voltage BNC connectors whenever the TEST VOLTS display indicates its numeric value and the LED on the left is illuminated. When used in Direct Mode only the R_x will have a voltage present at the center conductor of the high voltage. When used in Bridge Mode both R_s and R_x connectors will have a voltage present at the center conductor. While the source can only generate three or four milli Amperes at a steady rate, the output filter capacitors, can produce considerably greater currents for short periods of time. The SOURCE cables provided with the 6540 are HV BNC at the instrument end and Type-N at the U.U.T. end to provide direct connection with Guildline 9336 and 9337 series resistors. Other connector end cables are available as an option.

2.4.3.2. INPUT CONNECTOR

The sensitivity and very high impedances (100 k Ω) at this connector require careful handling. Large static discharges to this connector should be avoided. One terminal of the resistance or current is connected to the center conductor of the Triax connector. The INPUT cables provided with the 6540 are Triax at the instrument end and Type-N at the U.U.T. end to provide direct connection with 9336 and 9337 series resistors. Other connector end cables are available as an option.

2.4.4. REAR PANEL CONTROLS

Rear Panel controls are shown in Figure 2-4.



Figure 2-4: 6540 Rear Panel Connectors

2.4.4.1. IEEE-488 INTERFACE

The **IEEE-488** interface consists of the standard **IEEE-488** interface connector. The **IEEE-488** interface provides the means for a computer system to obtain complete control of the 6540. Computer control can be implemented through IEEE-488 compliant software that utilizes the 6540 remote command set. IEEE interface adaptors and cables can be obtained through Guildline Instruments Limited, See Section 8.9.9 to determine which one is right for you.

2.4.4.2. RS232 INTERFACE

The **RS232** interface consists of the standard **RS232 DB9** interface connector. The **RS232** interface provides the means for a computer system to obtain complete control of the 6540. Computer control can be implemented through a standard **RS232** terminal program or **RS232** based software that utilizes the 6540 remote command set which is available from Guildline.

2.4.4.3. Ground Terminal

The ground terminal consists of a single binding post. The ground terminal is bonded to the chassis of the model 6540 and to power ground of the line input connector.

2.4.4.4. LINE INPUT CONNECTOR

The **Line Input Connector** is a combination of a 3-prong AC standard male connector, an ON/OFF switch and a fused input line voltage selector. The input line's voltage selector consists of a four-position selector and a fuse holder. The selector allows switching between the four possible settings: 100V, 120V, 220V and 240V. A 2 Amp time delay fuse is provided for the 100/120 V operation and a 1 Amp time delay fuse is provided for the 220/240 V operation. The voltage selector and fuse are set for the 240V operation at the factory (see Section 2.2)

2.4.4.5. EXTERNAL TRIGGER CONNECTOR

This rear panel connector shown in Figure 2-4 works when the TRIGGER SOURCE is set to external (See Section 4.4.4) to initiate a measurement each time the EXT TRIG signal pin in the connector is grounded. Internally, the signal pin (pin 1) of the connector is supplied with +5V through an LED and a 330 Ohm resistor. Figure 2-5 shows typical external trigger circuits.

2.4.4.6. INTERLOCK CONNECTOR.

This rear panel connector, shown in Figure 2-4 is a dual function connector containing an interlock control and a Resistivity test fixture Surface/Volume selection indicator signal. The interlock control and test fixture status interface connections can be wired externally as shown in Figure 2-6 for typical Interlock Circuit Configurations.

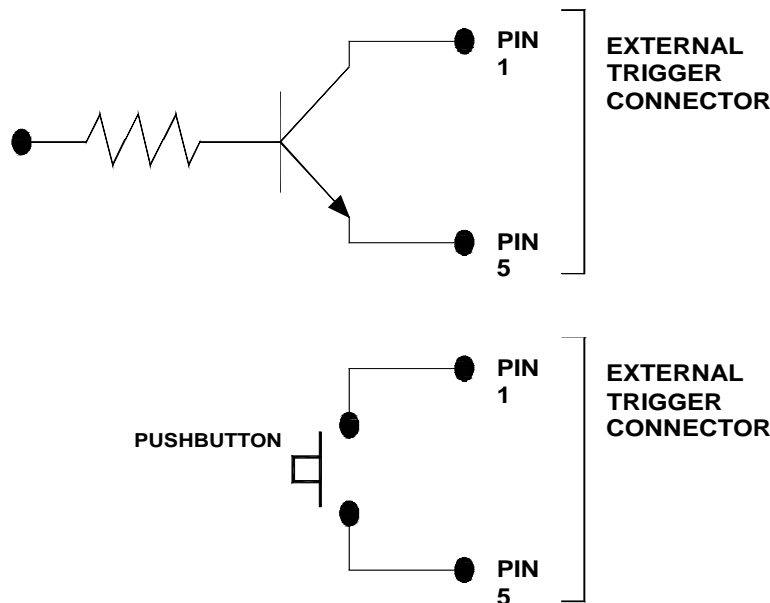

Figure 2-5: Typical External Trigger Circuits

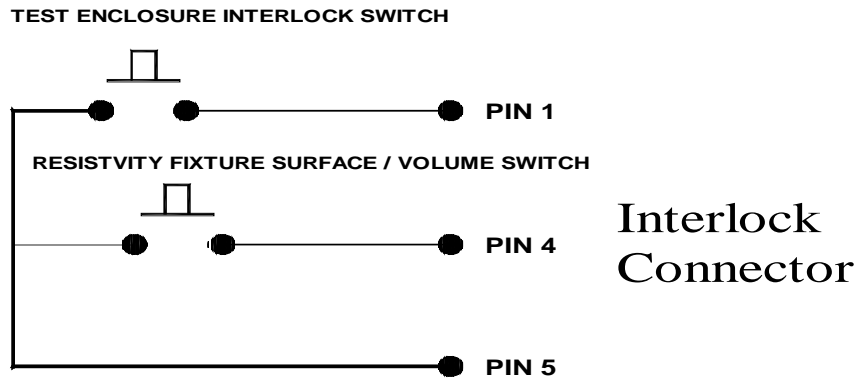

Figure 2-6: Typical Interlock Circuit Configuration

3. QUICK MEASUREMENT GUIDE

The 6540 although having many features and functions allowing in depth control of the measurement process, has been designed for ease of use. The auto-ranging and auto-reverse functions are exclusively used in Bridge Mode and are the best choice in most Direct Mode applications. This section outlines the basic measurement procedure using Direct Mode of operation.

3.1. RESISTANCE MEASUREMENT

Most high and ultra-high value resistors come as a 2 or 3 terminal device. An example of each is the Guildline model 9336 resistor which is a 2-terminal device, and a model 9337 which is a 3-terminal device. The measurement procedure for both the 9336 and 9337 is identical. They both have a “Source” and an “Output” connector. The “Source” (voltage in) connector of the resistor should be connected to the “Source” (voltage out) connector of the 6540. Note that the center pin is the applied voltage with respect to the outer shield (chassis ground).

Note: Lethal voltages of up to 1000 volts may be present at this output and appropriate precautionary measures are necessary.

For Direct mode only the two upper connections should be used (i.e. under the ‘Rx’ label). The two lower connections are only used for Bridge Mode to connect the reference resistor (i.e. R_s). The “Output” (current out) connector of the resistor should be connected to the “Input” (current in) connector of the 6540. Note that the center pin is the return current with respect to the outer shield (chassis ground). The cables inner shield (electrometer ground) is shorted to the outer shield to allow for a common reference to the internal voltage supply. Refer to Figures 3-1 and 3-2.

3.1.1. DIRECT RESISTANCE MEASUREMENT PROCEDURE

To make a Direct Mode resistance measurement, do the following steps.

1. Connect the unknown resistance device to the upper Direct terminals (i.e. Rx).
2. Select the <Measure> function key in the **Main Menu**
3. Select the <Ohms> function key in the **Measure Option Menu**
4. Select the <Setup> function key in the **Measure Ohms Menu**
5. Select the <Parameters> function key in the **Ohms Setup Menu**
6. Select the <Max Volts> function key in the **Ohms Parameters Menu**
7. Select the “Previous” key twice to return to the **Measure Ohms Menu**
8. Select the <Start> function key to initiate the measurement cycle.
9. The 6540 will proceed to determine the correct range and take continuous measurements.

3.1.2. 2-TERMINAL RESISTANCE CONNECTION SCHEMATIC

Outlined below is an example of a typical 2-terminal resistance device connected to the 6540. Note that the known voltage is dropped on the U.U.T. resistor element and the resultant current is returned to the electrometer to be measured. The resistance is determined by the measured current and known voltage.

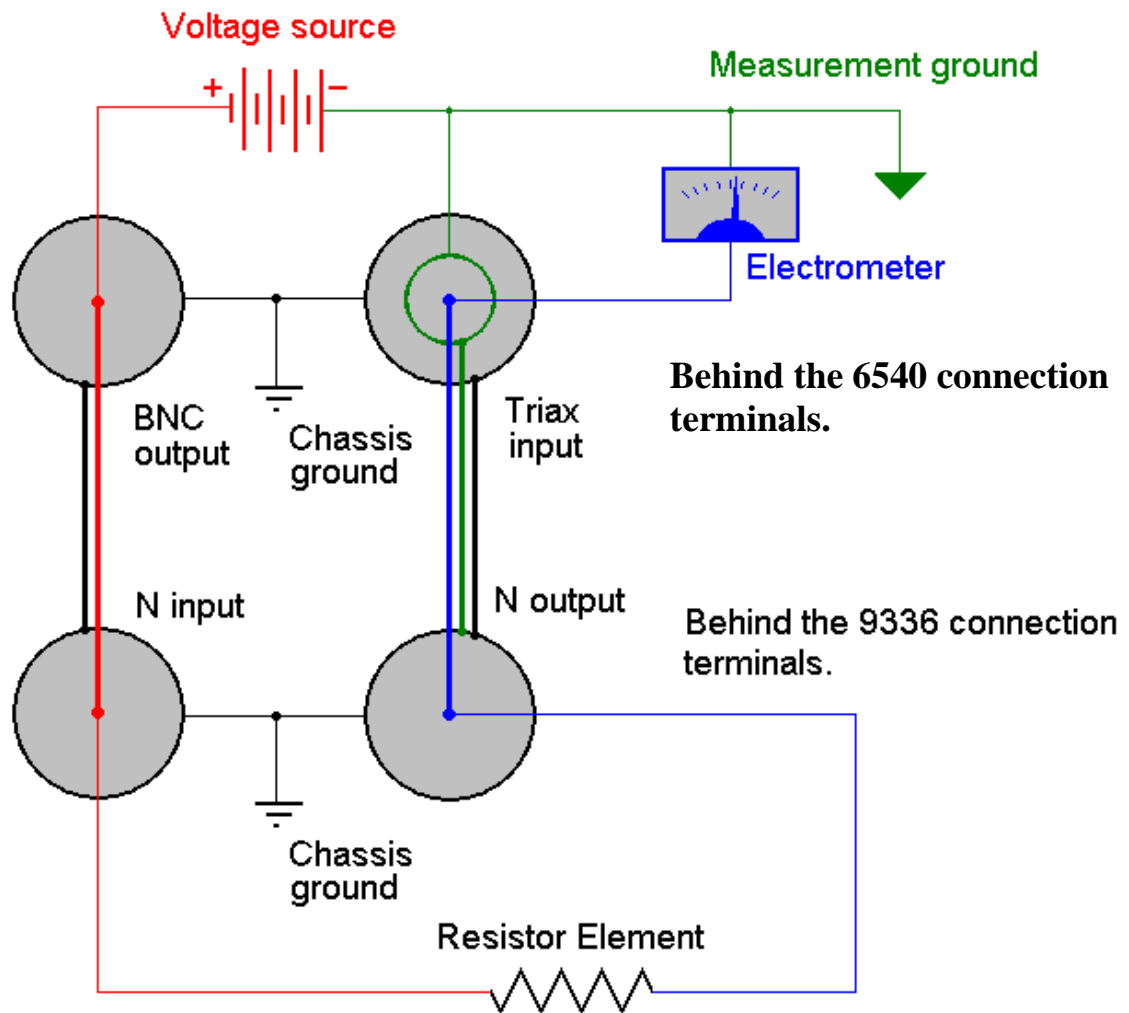

Figure 3-1: 2-Terminal Resistance Measurement Schematic

3.1.3. 3-TERMINAL RESISTANCE CONNECTION SCHEMATIC

Outlined below is an example of a typical 3-terminal resistance device connected to the 6540. Note that the known voltage is dropped on the U.U.T. resistor elements and the resultant current is ratio divided and partially returned to the electrometer to be measured. The effective resistance is determined by the measured return current and known voltage.

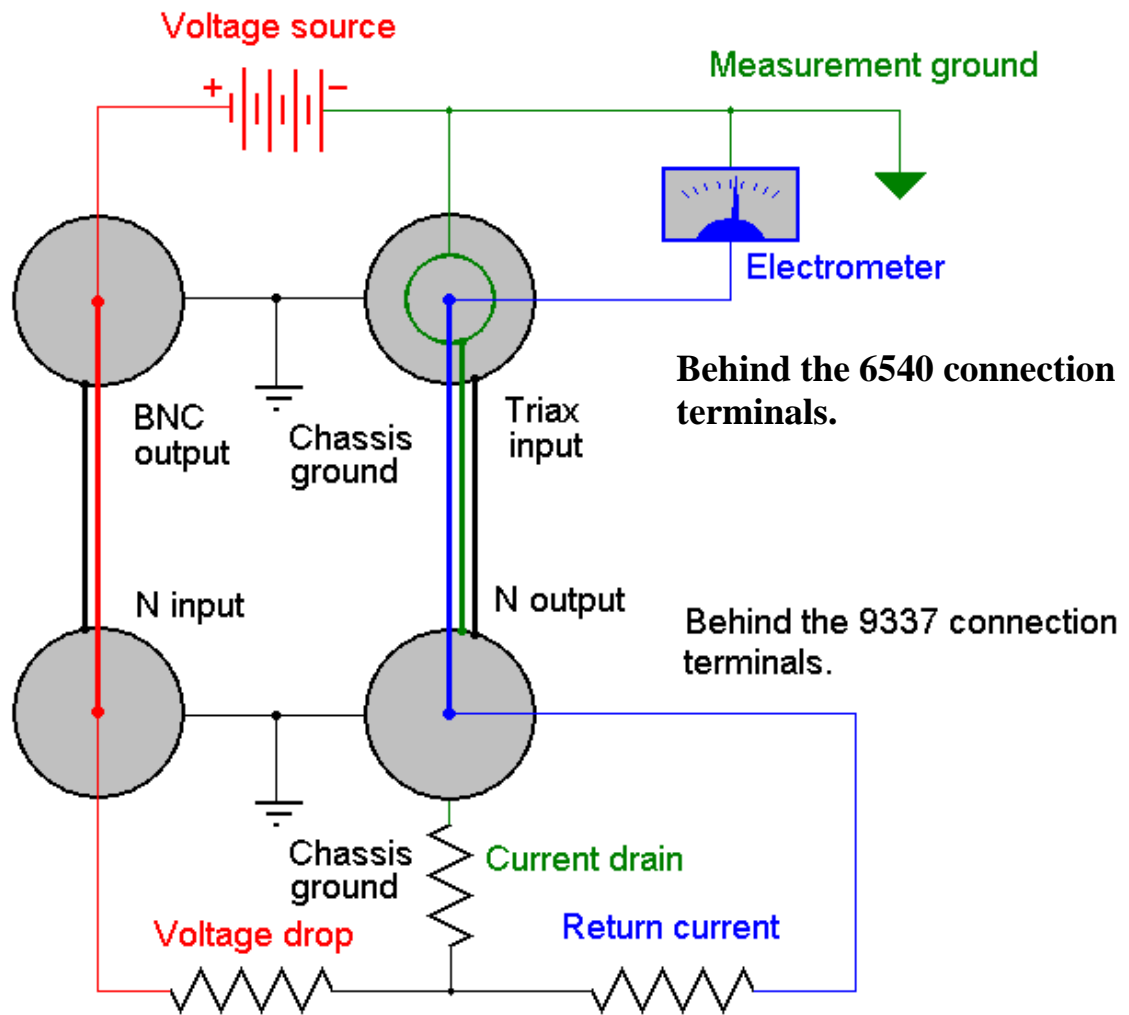

Figure 3-2: 3-Terminal Resistance Measurement Schematic

3.2. BRIDGE VS DIRECT MEASUREMENT

Set up of bridge mode consist of selecting a R_s and R_x of no more than a 1:100 ratio. Only ratios that auto range to the same capacitor can be measured in Bridge mode because the uncertainty of different capacitors is too large to exact a resistance measurement of value. When using the Bridge mode, parameters will auto range for the best reference resistance standards available to the operator. Manual parameter setting is disabled in bridge mode to ensure the measurement parameters are the same for R_s and R_x . When measuring a resistance value using Bridge mode, you should have both resistors housed in a temperature stabilized and shielded enclosure, to avoid delays waiting for the UUT to stabilize after measuring the resistance standard. Keep the measurement cycle times longer rather than shorter, as speeding up a measurement will result in more noise. A good practice for Bridge and Direct modes is to take 300 samples using the last 50 for the mean and standard deviation. The operator must ensure that the reference resistance standard is calibrated at the required voltage. Otherwise, the voltage co-efficient must be used when determining the error at voltages other than the calibrated point of the standard, resulting in increased uncertainty. In Bridge mode maintaining the same capacitor and threshold settings allows for an effective Ratio for UUT:REF of 1:1, 1:10, 1:100, and in some specific cases can be extended to 1:1000, although 1:1000 ratios are not calibrated. To maintain these conditions, particular care should be maintained when working with ratios which are not at 1:1 to keep the ramp time in the electrometer between 500 millisecond and 1 minute. A list of common test setups can be found in the manual in Section 8.2 with the ramp time shown in the Table 8-4. Since the test parameters are the same, the calibrated resistance and the uncertainty of the UUT by the Bridge Mode are characterized by the following equations (1) and (2):

$$R_{xc} = R_s * R_x(m) / R_s(m) \tag{1}$$

Where:

R_{xc} = Calibrated resistance value of the UUT

$R_x(m)$ = Measured resistance value of the UUT by the 6540

R_s = Previously known calibrated resistance value of the resistance reference standard

$R_s(m)$ = Measured resistance value of the resistance standard by the 6540

$$UR_{xc} = \text{SQRT}[(UR_s^2 + UR_{s(m)}^2 + UR_{x(m)}^2 + U_{\text{meter}}^2)] \quad (2)$$

Where:

UR_{xc} = Measurement uncertainty of the calibrated resistance value of the UUT

$UR_{x(m)}$ = Measurement uncertainty of the measured resistance value of the UUT by the high resistance meter (2 times the standard deviation)

UR_s = Measurement uncertainty of the previously known calibrated resistance value of the resistance standard (typically $k = 2$)

$UR_{s(m)}$ = Measurement uncertainty of the measured resistance value of the resistance standard by the high resistance meter (2 times the standard deviation)

U_{meter} = Uncertainty of the 6540 in bridge mode (use the bridge specifications based on R_s and ratio)

PROCEDURE: Direct Mode 1 GΩ example (100 MΩ to 1 GΩ example)

Step 1) Ensure the 6540 has been powered on. The unknown resistor (R_x) should be placed in a stable temperature controlled environment and sufficiently EMI shielded.

Step 2) For Direct Mode, connect the R_x resistor on the upper terminals under the 'Rx' label. For this example, the reference resistor is a 1 GΩ resistor. The measurement should run for 300 samples keeping the last 50 for determination of standard deviation and mean. The optimum measurement parameters for a 1 GΩ resistor is Test Voltage of 10 V using the 2700 pF capacitor and 10 V threshold.

Step 3) The actual value unknown resistance is displayed.

PROCEDURE: Bridge Mode 100 MΩ : 1 GΩ example (100 MΩ Reference with 1 GΩ unknown)

Step 1) Ensure the 6540 has been powered on. The Unknown resistor with nominal value of 1 GΩ should be connected as described above in the Direct Mode example. Connect the known reference resistor (Rs) with nominal value of 100 kΩ on the lower terminals above the ‘Rs’ label. Both resistors (i.e. Rs and Rx) should be placed in a stable temperature controlled environment and sufficiently EMI shielded.

Step 2) For this example the known reference resistor is a 100 MΩ resistor with a traceable uncertainty of 10 ppm. The measurement should run for 300 samples keeping the last 50 for determination of standard deviation and mean. The optimum measurement parameters for a 100 MΩ resistor is Test Voltage of 1 V using the 2700 pF capacitor and 10 V threshold.

Step 3) The actual value unknown resistance or the ratio is displayed based on what is requested.

3.3. CURRENT MEASUREMENT

All current sources come as a 2-terminal device. The “Output” (current out) connector of the current source should be connected to the “Input” (current in) connector of the 6540. Note that the center pin is the current path with respect to the inner shield (electrometer ground). The outer shield is primarily used for noise immunity purposes in current measurements. Refer to Figures 3-3. Many current sources also use the chassis ground as their current output reference which can be fine to short to measurement ground using the standard cable set supplied with your 6540. However, there are also cases where the current output is isolated from chassis ground. The inner shield must be used for measurement ground and **NOT** connected to the outer shield in these cases. Also note that in many cases there are active guard connectors on current sources which should **NEVER** be connected to the 6540 as damage to both devices will likely occur. Using the triax to 3-alligator connection cable found in the 6540 Lead Set Option 65225 will assist in these more complex setups.

3.3.1. CURRENT MEASUREMENT PROCEDURE

To make a current measurement, do the following steps.

1. Connect the unknown current source.
2. Select the <Measure> function key in the **Main Menu**
3. Select the <Current> function key in the **Measure Option Menu**
4. Select the <Start> function key to initiate the measurement cycle.
5. The 6540 will proceed to determine the correct polarity/range and take continuous measurements.

3.3.2. CURRENT SOURCE CONNECTION SCHEMATIC

Outlined below is an example of a typical current source device connected to the 6540. Note that the known voltage source is not required or used and the current is actively driven from the unknown current source to the electrometer to be measured. While many current sources are referenced to chassis ground, some may not be. Use caution and refer to your current source documentation when connecting these devices. Current sources that do not use chassis ground as a reference should only be connected to the inner shield of the 6540 Input connector.

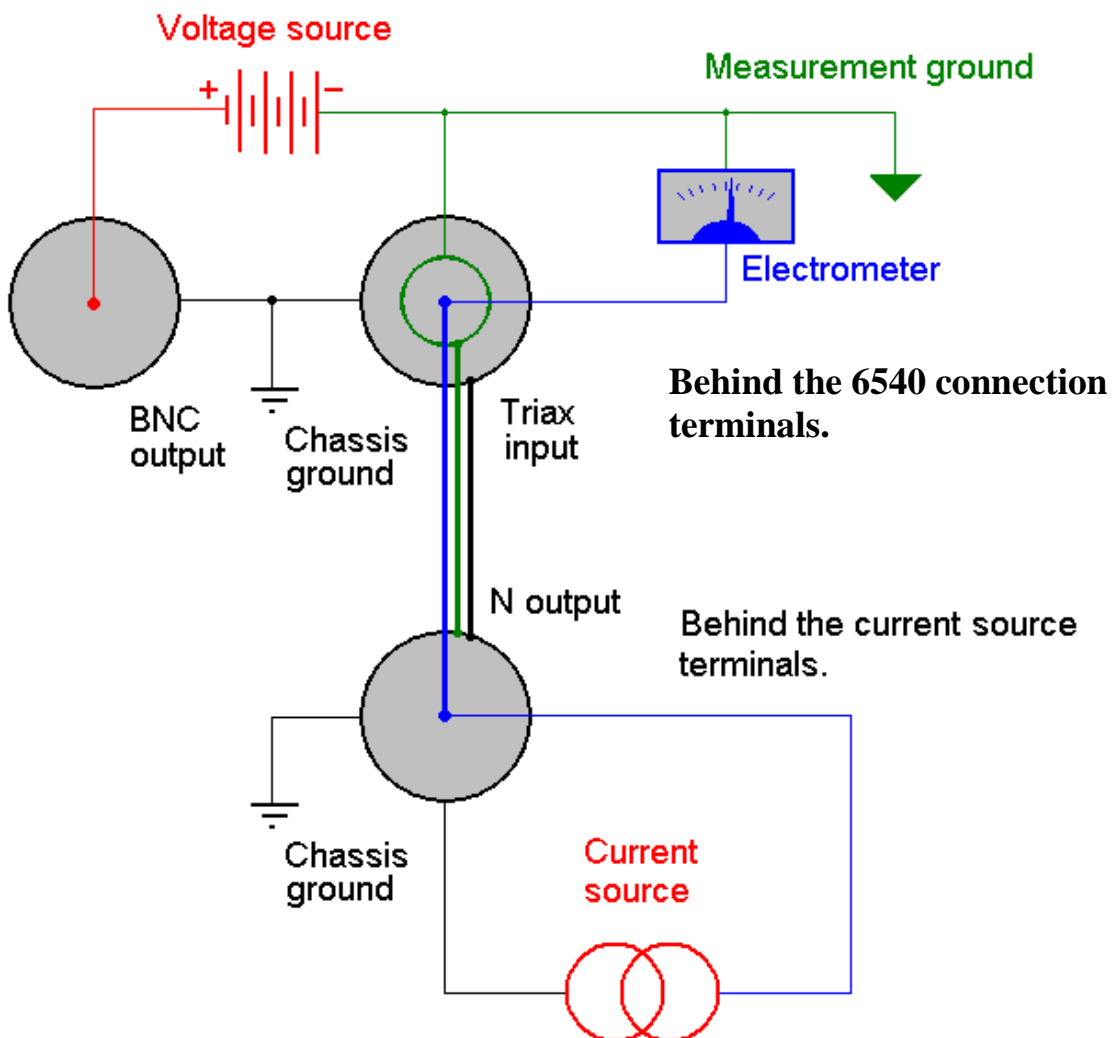

Figure 3-3: Current Source Measurement Schematic

4. INSTRUMENT OPERATION

Instrument operation is controlled from a menu display and command function key approach that uses the front panel graphic display, programmable function keys, cursor movement keys and numeric keypad arrangement. The comprehensive user interface used, prompts the operator for the next required keystroke or it will automatically perform the required function on selection of the displayed operation.

CAUTION

**DANGEROUS VOLTAGES CAN BE PRESENT AT THE SOURCE CONNECTORS.
THIS EQUIPMENT MUST NOT BE OPERATED BY UNQUALIFIED PERSONNEL.**

4.1. BASIC MENU OPERATION

4.1.1. Menu System

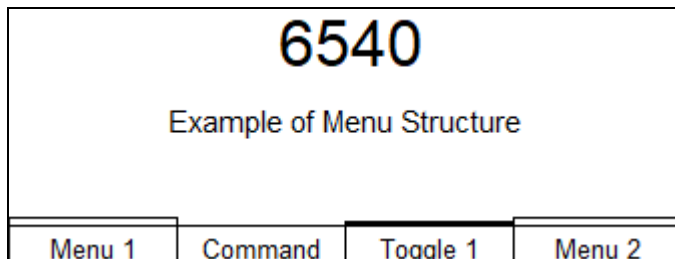

The basic screen structure of the 6540 has allocated the last two (2) lines of the screen to four (4) function keys. The last line contains 10-character descriptions of the function to be performed. The menu system is hierarchical, and the box of the function key has three (3) possible states.

“Menu 1” has a double box and indicates that invoking this key will select a sub-menu.

“Command” indicates that this is a command key, and the specified action will take place when the key is pressed.

“Toggle 1” has a double width line as a box and this indicates that this key will toggle through the defined states. In this mode the function box indicates the current state of the key.

4.1.2. Key functions

Four (4) function keys are software defined within the text on the screen.

The <cancel> key cancels any data entered during an edit operation.

The <previous> key causes the menu system to return to the previous menu level.

Numeric keys (0-9) are used to enter data during the edit operations.

The <clear> key is used to clear the current entry during edit operations.

The <exponentiation> key is used for floating point data entry.

The <minus> key is used for negative numbers or as a dash in text entry.

The <period> key is used for floating point numbers during an edit operation.

The <load> key is equivalent of the enter key.

4.1.2.1. Navigation keys (up/down, left/right arrow)

Edit mode.

The left arrow is used to move left to a desired location in an edit field.

The right arrow is used to move right to a desired location in an edit field.

The up arrow is used to enter the existing field and to select the previous field.

The down arrow is used to enter the existing field and to select the next field.

Select mode.

The up arrow selects the previous field.

The down arrow selects the next field.

The left arrow scrolls to the previous column of data if it exists, otherwise it will select the first field.

The right arrow scrolls to the next column of data if it exists, otherwise it will select the last field.

View mode.

The view portion of the 6540 uses the navigation keys to allow easy movement within the data environments.

1. Summary data.

All navigation keys are not active.

2. Detail data.

The left arrow positions to the beginning of the trace buffer.

The right arrow positions to the end of the trace buffer and also activates an automatic refresh every 3 seconds.

The up arrow will scroll the data up by one entry.

The down arrow will scroll data down by one entry.

4.1.3. Select Mode

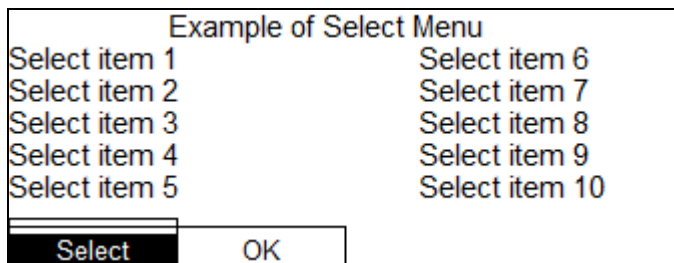

Select mode allows the selection of a specific item from a list using the navigation keys. The item is selected using the ok function key.

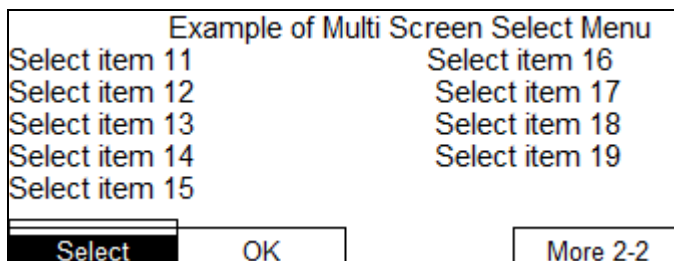

If the selections do not fit on a single screen then the fourth function key is reserved for navigating between the multiple screens.

4.1.4. Edit Mode

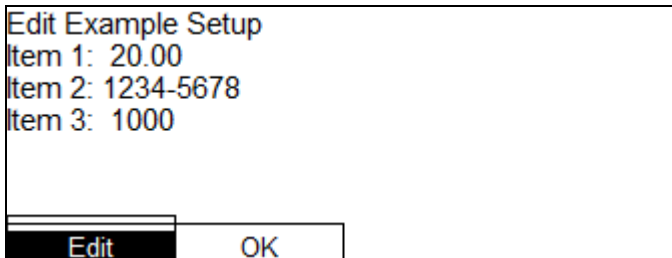

Data is entered using the numeric keys. The cancel key will restore all values to their original state. All of the data that has been changed is saved using the ok function. Multiple screens of data are processed using function key 4 (more n-n).

4.2. MAIN MENU

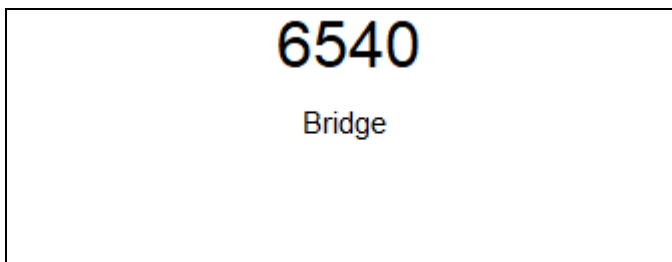

At power ON the model 6540 will start its internal power on self-test programming and display its opening banner:

When the instrument is turned on it performs a series of internal diagnostic checks. The internal diagnostics check the power supplies, reference voltage and system memory.

If the display shows the message Non-Volatile Memory Failure Press any key to continue, it indicates that the calibration data in the instrument memory has been corrupted and the operator should re-enter the proper coefficients (see SOFCAL).

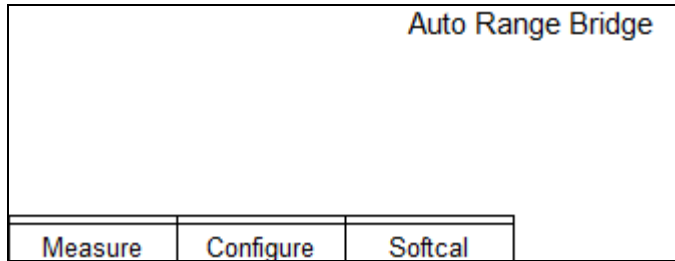

<**Measure**> is the operations sections of the system.

<**Configure**> allows the setting up of the operating environment. An example of this would be to setup the display resolution for a measurement, GPIB settings, etc.

<**Softcal**> is the calibration and diagnostics section of the system. Most of this section is under password control.

Pressing any key will remove the opening banner routines.

The REMOTE DISPLAY screen will appear only when the model 6540 has been addressed by a remote communication device on the GPIB.



The only active soft function key that will work when in Remote mode is the function key <**Remote**>. The exception is when local lockout has been enabled; in this case none of the keys on the front panel will be enabled.

4.3. Measurement Menu

Bridge			
Ohms	Current	Surface	Volume

4.4. Ohms Measurement Menu

Auto Range Bridge			
Start	Rxc Value	Setup	More 1-2

In Bridge mode, the 6540 only operates with auto ranging. Auto range and manual mode are available for Direct mode and it is recommended that auto range mode be selected whenever possible in Direct mode.

As with all precision measurement instrumentation, the 6540 Dual Measurement High Resistance Bridge input is very sensitive to external stray electromagnetic and electrostatic fields. The presence of these stray fields can adversely affect the resistance under test as well as the 6540 reading. Proper measurement techniques for handling high impedance circuitry should be used and care should be taken to shield any device that is to be measured. Inadequate shielding will result in unstable readings. The reader should consult Section 8.7 when large value resistances are to be measured.

NOTE that POTENTIALLY LETHAL VOLTAGES CAN BE PRESENT AT THE SOURCE CONNECTOR when the measurement process is initiated. The yellow LED indicates if the voltage is present. The 6540 default maximum voltage setting is 30 volts as required by ISO safety regulations. If test voltages higher are required the maximum voltage setting must be changed in the setup menu as per section 4.4.2. For the Auto Ranging mode to function properly above 10 GΩ the maximum voltage setting should be set to 1000 volts.

<Start> initiates the autorange function. If you have configured the 6540 to be in “Prompt” mode (factory default see section 4.9) then you will be greeted with the option to keep or clear the data built up from the previous measurement, and have the option of setting the measurement parameters. If the choice is not made in 3 seconds the 6540 will default to keeping the previous data and will autorange to determine the ohmic value(s) being measured and setup the default measurement parameters.

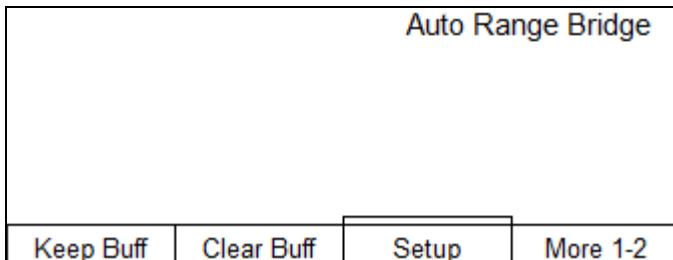

The 6540 will check the value of the resistor and select the optimum parameters for measurement purposes. It will report the approximate setting that it is trying to use as it locates the best settings.

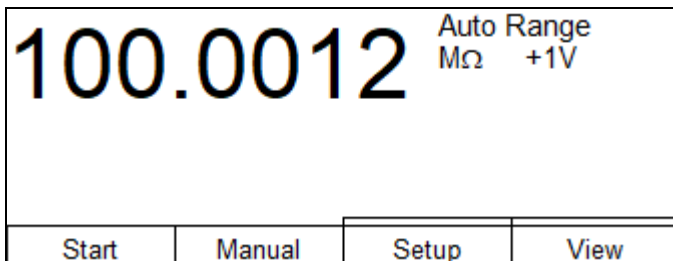

The 6540 will display the measurement values as they become available. It will also display the voltage that is being supplied to the output terminal. This example illustrates +1 volts.

4.4.1. Ohms Setup

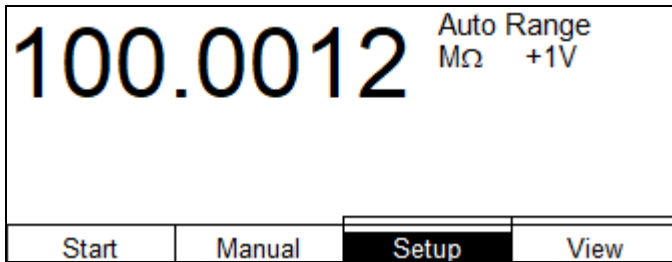

If some of the current settings need to be viewed or changed, selection of the Setup sub-menu is required.

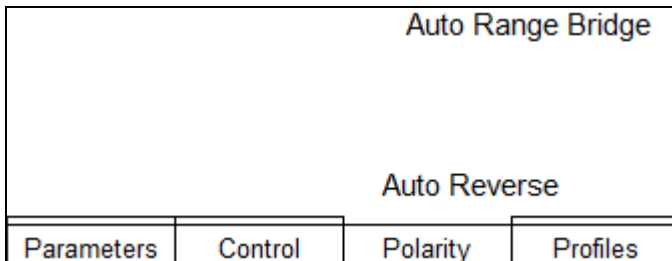

The setup menu allows the user to select the polarity using the polarity command function.

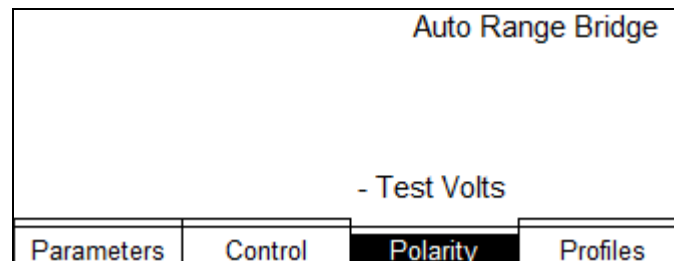
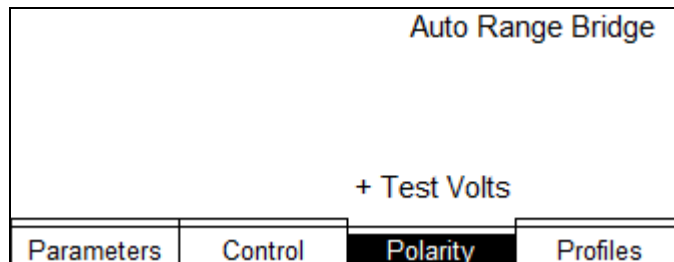

Changing polarity will not stop the measurement. It is recommended that attention is paid to the parameters for auto reverse as this will drastically affect the accuracy of the measurement. Voltage reversals for measurements greater than 10 GΩ require longer settling time. If the system is configured in 6540 mode and Bridge Mode or auto-ranging in Direct Mode is used, then the system will automatically select appropriate parameters for sample size and sample count based on the resistance. (see section 4.9.2.2.5 System parameter) In Direct manual mode Auto Reverse Sample Count and Stabilize Size (4.4.6. Timers) are used to establish these values.

4.4.2. Ohms Parameters Menu

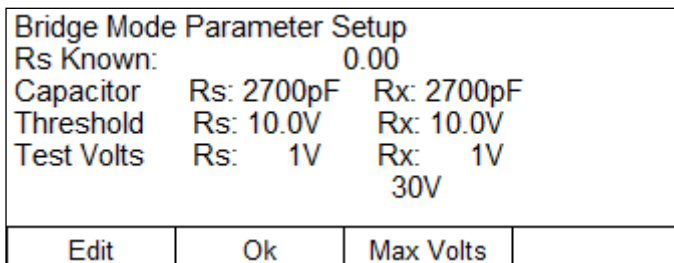
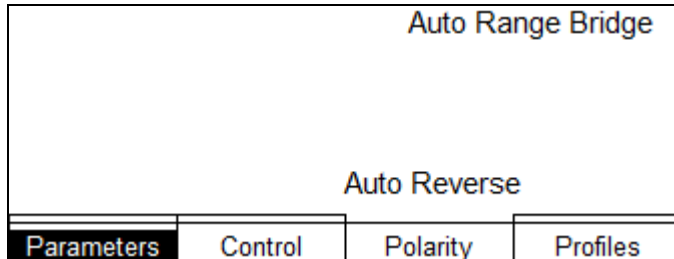

The parameters show the settings for Bridge mode. The settings have to match based on the ohmic value and ratio chosen. So the Capacitor, Threshold, and Test Volts cannot be changed.

Selection of the Edit command is disabled for Bridge mode.

The Capacitor shows the value of the integrating capacitor. The valid capacitor values are: 27 pf, 270 pf, or 2700 pf. The 27 pf and 270 pf selections are only available if the 0.1 V threshold is used.

The Threshold shows the threshold voltage. The valid Threshold voltages are: 0.1 V, 1.0 V or 10.0 V.

The Test Volts shows the voltage to be used during the measurement. The valid Test Volts values are: 1 V, 2 V, 5 V, 10 V, 20 V, 50 V, 100 V, 200 V, 500 V, or 1000 V.

The Max Volts limits all measurements, including those done with auto ranging. Max Volts is set to 30 V as power up default for safety reasons. This is important to note as some resistors may be damaged if too high a voltage is applied. The valid ranges are: 1 V, 2 V, 5 V, 10 V, 20 V, 50 V, 100 V, 200 V, 500 V, and 1000 V.

Selecting the Max Volts key will toggle through the different maximum voltages. The Max Volts selections are the same as the voltage range selections, however the selected voltage range cannot be greater than the Max Volts. The Max Volts will have to be increased if the desired voltage is greater than Max Volts. This is a deliberate limit to ensure that the voltage is not accidentally changed above the tolerance of the resistor. In Auto Range mode the 6540 will not provide a calibrated measurement if Max Volts is set too low.

Note that in Auto Range mode the parameters are automatically selected up to the Max Volts setting.

4.4.3. RESISTANCE, MANUAL RANGING

Manual ranging of the 6540 Dual Measurement High Resistance Bridge is more complex than using the auto ranging function. Manual ranging can only be used in Direct Mode. To fully understand the manual mode, Section 1.1.2 (Principle of Operation) should be reviewed.

The manual mode permits the operator to select the test voltage, the threshold voltage and the integration capacitor. The operator may also select these constants through the GPIB or RS-232C remote communication link. The instrument then measures the integration time and calculates the value of the unknown resistance. If the operator selects inappropriate measurement constants, the full accuracy of the instrument may not be achieved. To make a good selection, an approximate value of the unknown resistor is required. This may be obtained from a prior knowledge or from a repetitive sequence of measurements starting from any assumed value. The instrument works best if the integration time is between 0.54 and 54.0 seconds, however it will work at reduced accuracy with an integration time as short as 5.4 milliseconds or as long as 1000 seconds. The integration capacitor value may be selected from one of 27, 270 or 2700 picofarads. The 2700 pF capacitor is the most stable and should be used if possible.

The threshold may be 0.1 V, 1 V or 10 V. The test voltage may be selected in steps that are 1 V, 2 V, 5 V, 10 V, 20 V, 50 V, 100 V, 200 V, 500 V, or 1000 V of either polarity (\pm).

The integration time is affected by the selection of the capacitor, threshold and test voltage according to the formula:

$$T = \frac{2 \times C \times R \times V_{\text{threshold}}}{V_{\text{source}}}$$

Where: T is the integration time in seconds,

R is the unknown resistance in ohms,

C is the integrator capacitance in farads,

$V_{\text{threshold}}$ is the threshold voltage in volts,

V_{source} is the test voltage in volts.

The operator may use the system parameters table (Table 8-6) to select the measurement constants without calculation. For example, if the unknown resistor value is approximately 100 M Ω , the operator will find the 100 M Ω on the table with applicable voltages. The measurement of the 100 M Ω with 10 V test voltage using the 2700 pF capacitor it can be seen that selecting a 10 V threshold will give an integration time of 540 ms which is within the optimum range of 0.54 to 54.0 seconds. The selection of the 0.1 V threshold should be avoided because it would give an integration time of 5.4 ms.

Another thing that should be considered is the voltage used within the measurement. If the measurement is being performed at low voltages (100 V or less) then the integration time is best to be within 5.4 to 54 seconds. This longer integration time will improve the stability of the inherently lower signal to noise ratio with lower voltages.

4.4.4. Control Menu

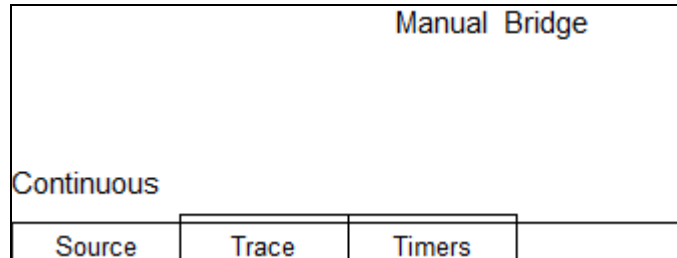

The valid Source selections are:

- Continuous - continuous measurement
- Manual - requires trigger from <Trigger> function key to start a measurement. <Trigger> is also available on the Ohms Measurement Menu if this mode is selected
- External - external trigger contact closure required on external trigger source on input connector
- BUS - measurement initiated by *TRG remote command

4.4.5. Trace

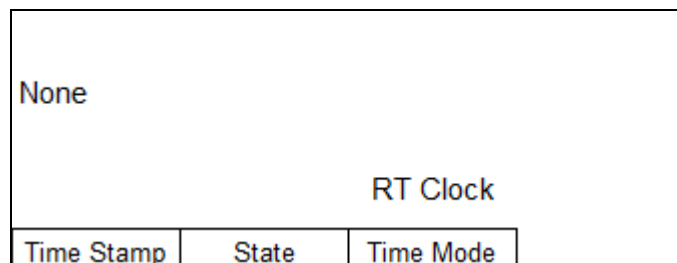

<Time Stamp> selects and removes the Time Stamp in the trace.

<Time Mode> toggles between Relative Time and the Real Time Clock. This is only traced if Timestamp is selected.

<State> toggles between Machine State and None. It selects and removes the machine state data from the trace.

4.4.6. Timers

Timers Setup			
Delay (s.nnn): 0:000			
Soak Time (s.nnn): 0.000			
Int Temp Timer (secs): 3			
Edit	Ok		

Delay is the time in seconds to wait between each sample. It is an internal time based sample trigger.

Soak Time is the initial settling wait time in seconds after a change in voltage or polarity.

4.4.7. Polarity

Toggles between '+' Test Volts and '-' Test Volts (i.e. polarity).

4.4.8. Profiles

Local			
GPIB			
RS232			
Select		Create	

Profiles allow the user to select standard default setups or to create individual user profiles. 36 profiles are available in the 6540; 3 are fixed (LOCAL, GPIB, RS232) and 33 are user definable. The remaining 33 profiles are stored in non-volatile memory and will be retained by the 6540 even after powering off.

<Select> allows the selection and deletion of profiles.

LOCAL			
GPIB			
RS 232			
User Profile 100 MOhm			
Select	OK	Delete	

<Ok> selects the highlighted profile.

<Delete> deletes the currently selected profile. This option is only available on user profiles and will not be present when LOCAL, GPIB, or RS232 is highlighted.

<Save> saves the current profile information in the selected profile.

The saved parameters are: Delay Time, Soak Time, Sensor Time, Trigger Source, Display Resolution, Display Brightness, Auto Reverse Mode, Manual Mode, GPIB status, RS232 status, Capacitor, Threshold, Polarity, Max Voltage, Output Test Voltage.

<Create> allows the creation of a new profile using the current profile information.

User 1			
Edit	OK	Scale	

<Ok> creates a new profile with the name as entered in the text. The current profile information will be saved in this profile.

<Scale> allows the insertion of special text for defining the resistor value. It toggles between M Ohms, G Ohms, T Ohms and P Ohms.

4.4.9. View

The **View Menu** allows the user to view the trace data in text format. It is accessed by selecting **<More 1-2>** on the Auto Range Bridge menu (i.e. menu that has the **<Start>** function). The last 1000 entries are kept in memory and the individual entries can be viewed. A summarization of the data is kept from the last **<Clear Sum>** point.

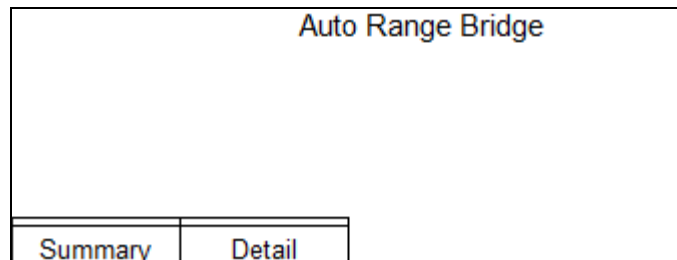

4.4.9.1. Summary

	Detail	Summary	100.00000Ω
Minimum	99.9979486	99.9979486	Rr
Maximum	99.9989347	99.9992902	Count
Average	99.9983568	99.9985756	1
Std Dev	2.96660102	3.88303008	(PPM)
Samples	24	38	
Refresh	Clear Det	Clear Sum	Rxc View

The Summary data being displayed is shown on the upper right. Rr indicates summary data for the reference resistor is being displayed. To change the summary data to show the calculated Rx value (i.e. Rxc) select **<Rxc View>**.

The **Count** entry indicates how many actual values have been averaged within the summary.

<Refresh> updates the detail and summary values.

<Clear Det> clears the trace buffer. It requires a confirmation to prevent accidental clearing.

<Rxc View> toggles between displaying data for the Reference Resistance Standard (Rr), and the Resistance being measured (Rxc).

4.4.9.2. Detail

	Time	ct	Volts
99.9980954	17:14:51.26	2	+10
99.9981951	17:14:51.27	2	+10
99.9982376	17:14:51.28	2	+10
99.9981986	17:14:51.29	2	+10
99.9982593	17:14:51.30	2	+10

Refresh	Rr View
---------	---------

<Refresh> updates the Detail display with the latest information.

The Up arrow scrolls the trace buffer up by one (1) entry.

The Down arrow scrolls the trace buffer down by one (1) entry.

The Left Arrow scrolls to the beginning of the trace buffer.

The Right Arrow scrolls the end of the buffer and sets the trace in automatic update mode.

The ct value is interpreted as follows:

c-t	Capacitor (pf)	Threshold (V)
0	27	0.1
1	270	1
2	2700	10

<Rr View> toggles between displaying data for the Reference Resistance Standard (Rr), Resistance being measured (Rxc).

4.5. Current - MEASURING PICOAMPERES

Auto Range Bridge			
Start	Manual	Setup	View

With the Current Option the 6540 Dual Measurement High Resistance Bridge can be used to measure very low Direct Currents flowing to the center conductor of the input connector. The 6540 input resistance is approximately 100 k Ω when measuring currents up to 10 μ A. To connect the unit as a pico-ammeter, the current source is fed into the center conductor of the INPUT connector. The INPUT connector inner shield is the current return path to the ground (or low side) of the external circuit. The connector outer shield is connected to the cable shield and safety ground of the 6540.

A coaxial cable to the INPUT connector makes a simple approximation to the ideal circuit configuration when the center conductor is connected to the current source and the coaxial shield is connected to the ground of the external circuit. Noise pickup may cause a slight degradation of accuracy when using this coaxial cable configuration. Guildline supplies a triaxial cable where the outer and inner shield are joined together at the Type-N connector end.

4.5.1. AUTO-RANGING - Current

The simplest technique for measuring low currents is to use the auto-ranging feature of the 6540:

1. Connect the unknown current source.
2. Select the **<Measure>** function key in the **Main Menu**.
3. Select the **<Current>** function key in the **Measure Option Menu**.
4. Select the **<Start>** function key to initiate the measurement cycle.
5. The 6540 will proceed to determine the correct range and take continuous measurements.
6. The auto-ranging feature of the 6540 will track slow changes in the magnitude of the unknown current, but if the current changes by a large step value, or if the polarity changes, the instrument must be forced to auto-range again by pressing the **<Stop>** function key to terminate the measurement and then the **<Start>** function key to initiate the measurement cycle.
7. Select the **<Set Up>** function key in the **Measure Option Menu**.
8. Change the polarity of the expected measurement process by selecting the appropriate polarity from the available options **<Polarity >** to get Positive or Negative polarity.
9. Press the front panel menu control key **<PREVIOUS>** to return menu control to the **Measure Option Menu**.
10. Select the **<Start>** function key to initiate the measurement cycle.

4.5.2. MANUAL RANGING - Current

Manual ranging of the 6540 Dual Measurement High Resistance Bridge is more complex than the auto-ranging function. It is only available in Direct mode. In order to manual range an approximate value of the current to be measured must be known.

Knowing the current the user must then select an integration capacitor and an integration threshold voltage. The integration capacitor value may be selected from one of 27 pF, 270 pF or 2700 pF. The threshold may be 0.1 V, 1 V or 10 V.

The selection of the capacitor and the threshold affects the integration time according to the formula:

$$T = \frac{2 \times C \times V_{\text{threshold}} \times 100 \text{ k}\Omega}{I}$$

Where: T is the integration time in seconds,

I is the unknown current in amperes,

C is the integration capacitance in farads,

$V_{\text{threshold}}$ is the threshold voltage in volts.

The instrument works best if the integration time of the electrometer is between 0.5 s and 5 s however integration times as short as 5.4 ms or as long as 1000 s may be used. The 2700 pF capacitor is the most stable and should always be used if possible.

The following steps can be used to measure current in the manual mode:

1. Connect the unknown current source.
2. Select the **<Measure>** function key in the **Main Menu**
3. Select the **<Current>** function key in the **Measure Option Menu**
4. Select the **<Set Up>** function key in the Measure Option Menu to proceed to the Set Up Menu
5. Select **<Parameters>** in the Set Up Menu to proceed to the Parameters menu
6. Using the suggested timing parameters suggested by entries of Table 8-6 to make the appropriate selection of **<Capacitor>** and **<Threshold>**.
7. Press the front panel menu control key **<PREVIOUS>** to return menu control to the Set Up menu.
8. Select the expected test current polarity using the **<Polarity>** function key; (the polarity convention used is such that for a positive polarity, the center conductor of the INPUT connector is at a positive voltage with respect to the inner shield.)
9. Press the front panel menu control key **<PREVIOUS>** to return menu control to the **Measure Option Menu**.
10. Select the **<Start>** function key to initiate the measurement cycle.

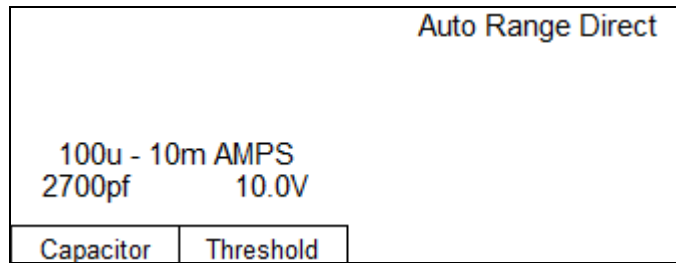

Capacitor 27 pF | 270 pF | 2700 pF
 Threshold 0.1 V | 1.0 V | 10.0 V

4.6. Surface Resistivity

Select <Measure> function key in the **Main Menu**
 Select <Surface> function key in the Measure Option Menu

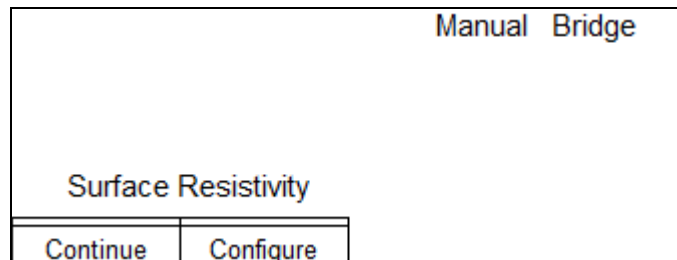

Select <Configure> function key in the Surface Resistivity Menu.

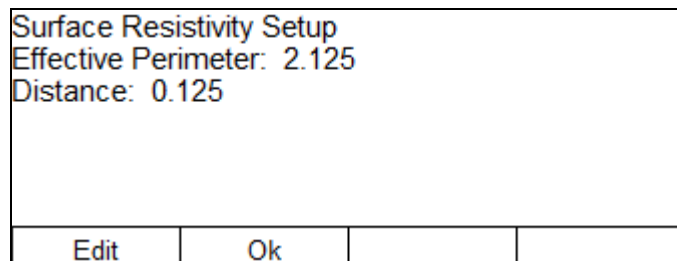

The effective perimeter and distance are fixed parameters for the Model 8009 Resistivity Test Fixture. For a detailed description of these parameters consult the Keithley Model 8009 manual.

<Continue> will set the system in Surface Resistivity mode and start the Ohms Menu (4.4).

4.7. Volume Resistivity

Select <Measure> function key in the **Main Menu**

Select <Volume> function key in the Measure Option Menu

Auto Range Bridge	
Volume Resistivity	
Continue	Thickness

<Continue> will set the system in Volume Resistivity mode and start the Ohms Menu (4.4).

4.7.1. Volume Resistivity Thickness Setup

Volume Thickness Setup			
Thickness: 0.125			
Inches			
Edit	Ok	Units	

The thickness of the sample can be changed from the default if necessary. Hit <Edit>, then use the numeric keypad to change the thickness. For a detailed description of these parameters consult the Keithley Model 8009 manual.

Units allows the selection of inches or centimeters. The configuration values are automatically converted.

4.7.2 Volume Resistivity Configure

Volume Resistivity Setup			
Diameter: 2.125			
Distance: 0.125			
Area Coefficient: 0.000			
Edit	Ok		

4.8. Configure

Select <Configure> function key in the **Main Menu**

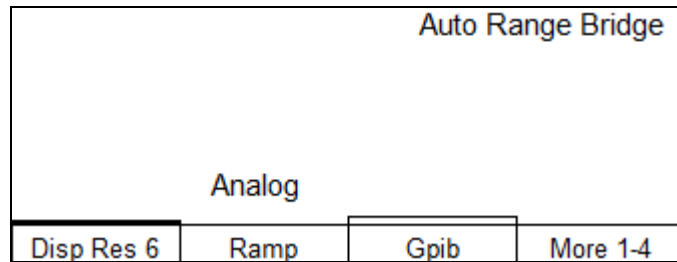

<Disp Res 6> Hitting this key toggles between ‘Auto Res’ which automatically chooses the display resolution; and toggles between ‘Disp Res 3’, ‘Disp Res 4’, ‘Disp Res 5’, ‘Disp Res 6’, ‘Disp Res 7’, and ‘Disp Res 8’. The ‘Disp Res x’ controls the number of digits displayed with ‘x’ being the number of digits.

Resolution for displaying the measurement. 3 | 4 | 5 | 6 | 7 | 8 | Auto Res.

<Ramp> The “Ramp” is the voltage output level of the integrating circuit of the electrometer. It is a good status indicator to show the circuit operation. Setting the “Ramp” to Digital displays ramp volts in digital and Analog displays the ramp graphically. Based on the selection ‘Analog’ or ‘Digital’ is displayed above the <Ramp> selection.

4.8.1. GPIB

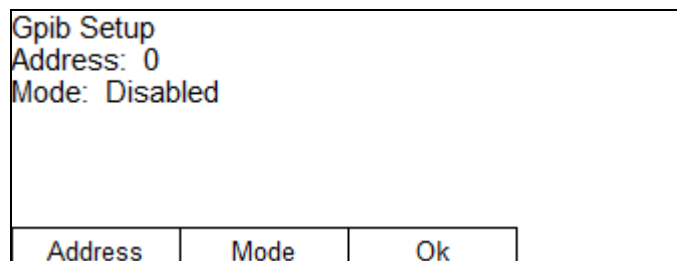

<Address> specifies the Gpib address and toggles between 0 and 30. The selected address is displayed on the screen. The standard device is 4.

<Mode> specifies the Gpib mode and toggles between: ‘Disabled’, ‘Talk Only’, and ‘Talk/Listen’.

<Ok> saves the parameters and initializes the device.

4.8.2. RS232

RS2132 Setup			
Baud: 4800		Flow Control: NONE	
Parity: None		Mode: Talk\Listen	
Stop Bits: 1			
Data Bits: 8			
Echo: OFF			
Baud	Parity	Stop Bits	More 1-3

Baud is the RS232 Baud Rate. 1200 | 4800 | 9600 | 19200 | 38400 | 115200.
 Parity NONE | EVEN | ODD
 Stop Bits 1 | 2

RS2132 Setup			
Baud: 4800		Flow Control: NONE	
Parity: None		Mode: Talk\Listen	
Stop Bits: 1			
Data Bits: 8			
Echo: OFF			
Data Bits	Echo	Flow Ctrl	More 2-3

Data Bits 7 | 8
 Echo ON | OFF
 Flow Control XON/XOFF | RTS/CTS | NONE

RS2132 Setup			
Baud: 4800		Flow Control: NONE	
Parity: None		Mode: Talk\Listen	
Stop Bits: 1			
Data Bits: 8			
Echo: OFF			
Mode	Ok		More 3-3

Mode Talk Only | Talk Listen | Disable

<Ok> is necessary to save the parameters and initialize the device.

4.8.3. Fixture

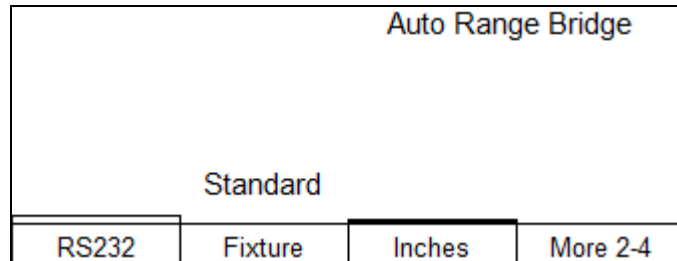

Fixture | Standard | Custom

Inches toggles between 'Inches' and 'cm'

4.8.4. Sys Time

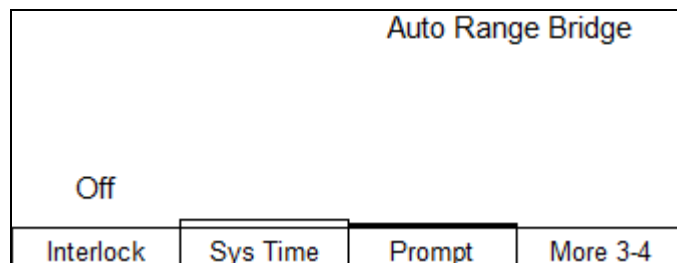

Interlock toggles between 'On' and 'Off'

<Sys Time> allows the updating of the system date and time.

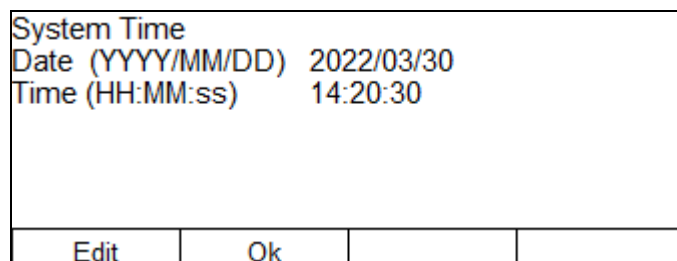

The time is entered in 24-hour format.

Prompt | Keep Data | Clear Data

4.9. Sofcal

<h1>Sofcal Menu</h1>			
User	Calibrate	Diagnostic	Password

Section 6 provides a detailed explanation of calibration with the Sofcal program.

4.9.1. User

Sofcal User Menu	
Bridge	
Rev 2 2021/11/24	
Cal Coeff.	Self Test

The <User> Screen displays the Firmware version, calibration coefficients, and runs a self test of the 6540.

4.9.1.1. Calibration Coefficients

This menu displays the Calibration coefficients. It can be updated to re-enter the coefficients from the calibration report provided with a 6540 in the event of a non-volatile memory failure. These values are determined during the factory calibration or by a calibration previously done by a third party.

Calibration Coefficients			
-1.00000000	-50.00000000		
-2.00000000	-100.00000000		
-5.00000000	-200.00000000		
-10.00000000	-500.00000000		
-20.00000000	-1000.00000000		
			Scrn 1-3

Calibration Coefficients			
+1.00000000	+50.00000000		
+2.00000000	+100.00000000		
+5.00000000	+200.00000000		
+10.00000000	+500.00000000		
+20.00000000	+1000.00000000		
			Scrn 2-3

Calibration Coefficients			
27pF	0	Prot.	100000
270pF	0		
2700pF	0		
0.1V	0		
1.0V	0		
			Scrn 3-3

4.9.1.2. Self Test

```
Self Test - (Rev 2 Date 2021/11/24)
Error Status : 0 0 0-00000000 0-0000
AUX ROM Checksums : -19592.6159
NVSRAM Checksum : -20167

OK          Press any key to exit
```

Self Test checks various parameters and displays the results.

- Error Status. Bit 0 – Non-Volatile checksum failure
Bit 1 – Rom checksum failure. Could be ROM/Aux ROM.
Bit 2 – Analog failure.
Bit 3 - +5 volts
Bit 4 - -5 volts
Bit 5 - +15 volts
Bit 6 - -15 volts
Bit 7 – Precharge
Bit 8 – High voltage monitor
Bit 9 – 10 volt reference
Bit 10 - Ramp
Bit 11 – Digital failure.
Bit 12 - +5 volts
Bit 13 - -5 volts
Bit 14 - +15 volts
Bit 15 - -15 volts

4.9.2. Calibrate

Sofcal Calibrate Menu		
Bridge		
Rev 2	2021/11/24	
Utilities	Cal. Vals	Ref. Vals

<**Utilities**> is used to calibrate the capacitors, thresholds, protection resistor and shunt.

<**Cal. Vals**> is used to enter or modify the test volts, threshold, protection resistor and shunt correction values.

<**Ref. Vals**> is used to enter/modify the instrument serial number, calibration date, auto cal parameters, zero parameters and shunt parameters.

4.9.2.1. Utilities

It should be noted that the instrument may not reach a stable state if it is running in a environment which has climate fluctuations or high levels of electrical or other interference. In some cases it may be necessary to change the variance or the standard deviation from the system default values as displayed in the “Ref-Vals” submenu. If any of the calibration routines is unable to meet the specification, then an error message <*** **Sample Maximum Exceeded**> will be displayed and the procedure will be aborted.

Utilities Menu			
Bridge			
Rev 2	2021/11/24		
Auto Cal.	Cap Cal.	Thresh Cal	Zero Cal.

4.9.2.1.1.Auto Calibration

Capacitor Calibration	
27pF	0
270pF	0
2700pF	0
Connect Reference Resistor and press Calc	
Calc	Abort

This automates the Capacitor and Threshold calibrations. It utilizes the same procedures as the Capacitor and Threshold calibration, but it automatically steps through the three capacitors and the two thresholds. It also automatically sets the calibration date from the system date/time.

<Calc> starts the automated procedure.

<Abort> stops the procedure and restores the values to their original state.

4.9.2.1.2. Cap Calibration

The calibration coefficient is the difference in parts per million (ppm) between the measured value and the current value of the three integrating capacitors used in the 6540. The three coefficient values are stored in the instruments memory and are used to compensate resistance measurements. If the capacitor values should ever change or if the value in memory should become corrupted, the SOFCAL program is able to measure the true value and store the new Capacitor coefficient value in the 6540 memory in place of the old stored value.

Capacitor Calibration	
27pF	0
270pF	0
2700pF	0
Connect Reference Resistor and press Calc	
Calc	Abort

Select the desired capacitor with the Up/Down Arrow and press <Calc>.

Capacitor Calibration				
27pF	0			+ 1 V
270pF	0			
2700pF	0	100001350 Ohms		
* spec err	var	11.54	std dev	5.50
	25	10 var	1.51	std dev
			Abort	

If the specified variance or standard deviation is exceeded, then the sample count is reset to zero and the failed spec is displayed on the 5th line of the display. Line 6 of the display consists of the total measurement count, the number of samples which have currently been taken for the valid sample set and the current variance (in ppm) and standard deviation (in ppm) for the valid sample set.

Capacitor Calibration				
27pF	0			+ 1 V
270pF	0			
2700pF	0			
	Variance	1.25	Standard Deviation	0.58
	Select Capacitor and press Calc			
Calc	Save	Abort		

When the number of samples specified has been measured and have not exceeded the specification then the calibration routine has successfully completed and the actual variance (ppm) and standard deviation (ppm) is displayed. If for some reason the routine continues until the maximum retries has been reached, then the last window of samples is used to generate the actual variance (ppm) and standard deviation (ppm) that is displayed. The values are not stored in the 6540 non-volatile memory. When the calibration is complete it will allow the user to <Save> the values or to select another capacitor and <Calc> the calibration coefficient.

4.9.2.1.3. Threshold Calibration

This is the difference in ppm between the measured value and the actual value of the threshold voltages occurring at the integrator output. The threshold coefficient values for the 0.1 V and 1 V thresholds are stored by the 6540 and are used to correct the unknown resistance and current measurements.

Threshold Calibration		
0.1V	0	
1.0V	0	
Connect Reference Resistor and press Calc		
Calc		Abort

Select the desired threshold with the Up/Down Arrow and press <Calc>.

Threshold Calibration		
0.1V	172	+1 V
1.0V	195	100001800 Ohms
*spec	err	var 7.54 std dev 2.50
	25	10 var 9.51 std dev 6.17
		Abort

If the specified variance or standard deviation is exceeded, then the sample count is reset to zero and the failed spec is displayed on the 5th line of the display. Line 6 of the display consists of the total measurement count, the number of samples which have currently been taken for the valid sample set and the current variance (ppm) and standard deviation (ppm) for the valid sample set.

Threshold Calibration		
0.1V	172	
1.0V	174	
Variance	12.25	Standard Deviation 8.78
Select Threshold and press Calc		
Calc	Save	Abort

When the number of samples specified has been measured and have not exceeded the specification then the calibration routine has successfully completed and the actual variance (ppm) and standard deviation (ppm) is displayed. If for some reason the routine continues until the maximum retries has been reached, then the last window of samples is used to generate the current variance (ppm) and standard deviation (ppm) that is displayed. The values are not stored in the 6540 non-volatile memory. When the calibration is complete it will allow the user to <Save> the values or to select another capacitor and <Calc> the calibration coefficient.

4.9.2.1.4. Zero Calibration

This is the value of the internal input resistance presented by the 6540 between the input connector and ground. The 6540 maintains a stored value for this resistance in its memory and subtracts it from all resistance measurements before the final value of the unknown resistance is put on the front panel display or made available at either control bus. If the ZERO CAL resistance should change or if the stored value should become corrupted in the memory, the 6540 is capable of re-measuring the true value and entering the true value into memory.

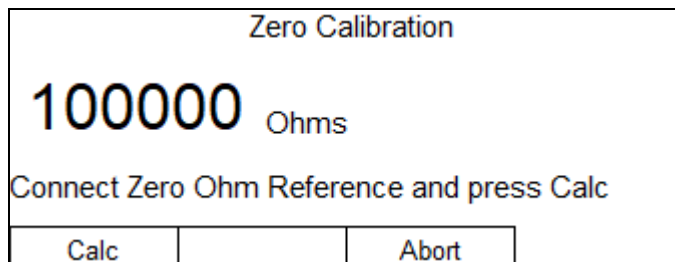

<Calc> starts the calibration procedure.

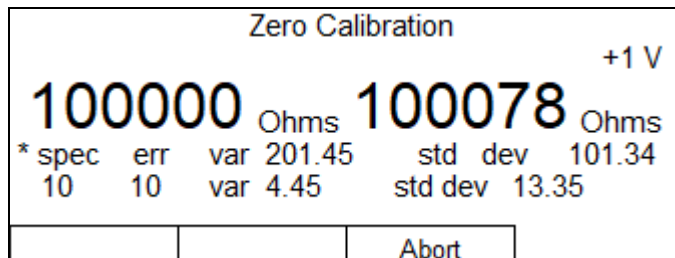

If the specified variance or standard deviation is exceeded, then the sample count is reset to zero and the failed spec is displayed on the 5th line of the display. Line 6 of the display consists of the total measurement count, the number of samples which have currently been taken for the valid sample set and the current variance (ppm) and standard deviation (ppm) for the valid sample set.

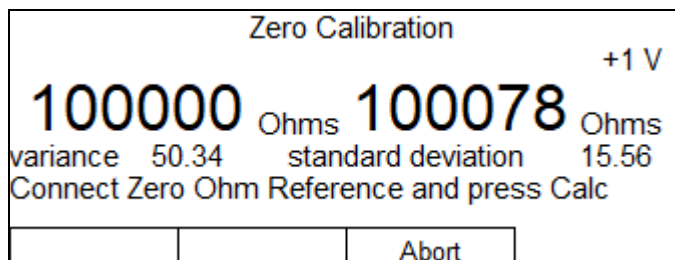

When the number of samples specified has been measured and have not exceeded the specification then the calibration routine has successfully completed and the actual variance (ppm) and standard deviation (ppm) is displayed. If for some reason the routine continues until the maximum retries has been reached, then the last window of samples is used to generate the actual variance (ppm) and standard deviation (ppm) that is displayed. The values are not stored in the 6540 non-volatile memory. When the calibration is complete it will allow the user to <save> the values or to select another capacitor and <Calc> the calibration coefficient.

4.9.2.2. Calibration Coefficient Values

Before accessing calibration coefficients, a password must be entered via the following screen. The default factory password is '6540'. Hit <Edit> to enter the password and <OK> to proceed.

PASSWORD CHECK			
Password:			
Edit	OK		

Sofcal Calibrate Menu		
Bridge		
Rev 2 2021/11/24		
Utilities	Cal. Vals	Ref. Vals

Press <Cal. Vals>

Sofcal Calibrate Menu			
Bridge			
Rev 2 2021/11/24			
Capacitors	Thresholds	Test Volts	More 1-2

4.9.2.2.1. Capacitor Coefficients

Pressing the <Capacitors> key will display the coefficients stored for each capacitor. By pressing the <Edit> key the numbers may be altered by pressing a new sequence of numbers followed by pressing the <Ok> key. Pressing the <PREVIOUS> key exits to the SOFCAL Calibrate Menu.

Capacitor Coefficients			
27pF	0		
270pF	0		
2700pF	0		
Edit	Ok		

4.9.2.2.2. Threshold Coefficients

Threshold Coefficients			
0.1V	0		
1.0V	0		
Edit	Ok		

Pressing the <Thresholds> key will display the coefficients stored for each threshold. By pressing the <Edit> key the numbers may be altered by pressing a new sequence of numbers followed by pressing the <Ok> key. Pressing the <PREVIOUS> key exits to the SOFCAL Calibrate Menu.

4.9.2.2.3. Test Volts

Voltage Values			
+1.00000000		+50.0000000	
+2.00000000		+100.000000	
+5.00000000		+200.000000	
+10.0000000		+500.000000	
+20.00000000		+1000.00000	
Edit	Ok		Scrn 2-2

Voltage Values			
-1.00000000		-50.0000000	
-2.00000000		-100.000000	
-5.00000000		-200.000000	
-10.0000000		-500.000000	
-20.00000000		-1000.00000	
Edit	Ok		Scrn 1-2

Pressing the <Test Volts> key will display the test voltages and the coefficients stored for each step. A new value may be entered for each test voltage by pressing the <Edit> key and the numeric keys for the new value, followed by the <Ok> key. Press the UP or DN key to select the next test voltage coefficient. The different test voltages are: (1; 2; 10; 20; 100; 200; 1000) V in both polarities (±). To determine the output test voltage coefficient a DC Voltmeter must be connected to the Output/Source connector. The following equation is used to calculate the value to enter for each output test voltage range. (see section 6.1.2)

$$\text{Test Voltage Coefficient} = \frac{\text{number to be keyed into display} \times \text{DC V reading} - |\text{Nominal Voltage}|}{|\text{Nominal Voltage}|} \times 10^6$$

Due to the large number of output test voltage points to be measured during calibration, it is recommended that the numbers are entered using one of the interface busses (GPIB or RS-232C).

4.9.2.2.4. Cal Spec.

	Count	Sample	Variance	Std Dev
27pF	0	0	0.000	0.000
270pF	0	0	0.000	0.000
2700pF	0	0	0.000	0.000
0.1V	0	0	0.000	0.000
1.0V	0	0	0.000	0.000

Press any key to exit

This displays the statistics of the last time that the Utilities were used to establish the Capacitor and Threshold coefficients. It displays the total count of samples required to meet the specification as well as the actual variance and standard deviation for the specified sample size.

4.9.2.2.5. System Parameters

Sample Count	90		
Sample Size	100		
Average Size	180	2700pF	10.0V
Window Size	30	Autorange	
Positive Coefficient	0		
Negative Coefficient	0		
Edit	Ok	90k - 200k	1V

Pressing the <Sys Params> key will display the system parameters stored for the 6540. <Function key 3> selects the resistance range. <Function key 4> selects the available voltage within the resistance range. By pressing the <Edit> key the numbers may be altered by pressing a new sequence of numbers followed by pressing the <Ok> key. Pressing the <PREVIOUS> key exits to the SOFCAL Calibrate Menu.

NOTE: Do not alter the system parameters as they will affect the accuracy of the 6540. These are factory set parameters. Access to the parameters is only recommended in the event of a non-volatile memory failure, to confirm and, if required, edit them to return them to the values set by the factory. These values are supplied in hard copy on the instrument report.

4.9.2.2.6. Protection Resistor

Protection Resistor Value Protection Resistor 100000			
Edit	Ok		

Pressing the <Protection> key will display the error stored for the internal series protection resistor. By pressing the <Edit> key the number may be altered by pressing a new sequence of numbers followed by pressing the <Ok> key. Pressing the <PREVIOUS> key exits to the SOFCAL Calibrate Menu.

4.9.2.3. Reference Values

4.9.2.3

Sofcal Reference Menu			
Bridge			
Rev 2 2021/11/24			
Serial Num	Cal Date	Ref. Res.	Ref. Zero

4.9.2.3.1. Serial Number

6540 Serial Number			
Serial Number 0			
Edit	Ok		

Used to record serial number from the back plate of 6540.

4.9.2.3.2. Calibration Date

Calibration Date/Time			
Date (YYYY/MM/DD) 2022/01/01			
Time (HH:MM:SS) 00:00:00			
Edit	Ok		

This is the date of last calibration. If a new calibration date is to be entered press the <Edit> key. A new date may be keyed in with the numeric keys of the keypad. The calibration date is saved when the <Ok> key is pressed. Pressing the <PREVIOUS> key exits to the SOFCAL Calibrate Menu.

This is used to record the last date of calibration. It needs to be updated when the 6540 is re-calibrated.

4.9.2.3.3. Reference Resistor

Reference Resistors			
Reference Resistor 100000000			
Serial Number			
Variance 2700pF (PPM) 5.00			
Standard Dev. 2700pF 2.50			
Sample Size 2700pF 30			
Edit	Ok		Scrn 1-4

Reference Resistors			
Variance 270pF (PPM) 7.00			
Standard Dev. 270pF 3.50			
Sample Size 270pF 60			
Variance 27pF (PPM) 10.00			
Standard Dev. 27pF 5.00			
Edit	Ok		Scrn 2-4

Reference Resistors			
Sample Size 27pF		100	
Variance 1.0V (PPM)		3.00	
Standard Dev. 1.0V		1.25	
Sample Size 1.0V		60	
Variance 0.1V (PPM)		12.00	
Edit	Ok		Scrn 3-4

Reference Resistors			
Standard Dev. 0.1V		3.50	
Sample Size 0.1V		100	
Min Elapsed Time (sec)		1800	
Maximum Sample Count		3000	
Edit	Ok		Scrn 4-4

This is used to record the value of the reference resistor used to calibrate the 6540. It is critical that it be entered prior to calibration of the 6540.

A separate value for variance, standard deviation and sample size is used for 2700 pF, 270 pF, 27 pF, 1.0 V threshold and 0.1 V threshold.

Variance is the difference between the maximum and minimum reading in ppm. This is used to ensure that the reading has stabilized before calculating the calibration coefficient.

Standard deviation (ppm) is used to further ensure that the measurement is stable and within spec.

Sample Size is used to specify the number of measurements to be used for calculating the coefficients.

Maximum Sample Count is set to specify the total number of measurements to be taken before the process is interrupted. Maximum Sample Count is a global setting for all tests in the Auto Cal functions.

It should be noted that the instrument may not reach a stable state if it is running in an environment which has climate fluctuations or high levels of electrical or other types of interference. This will result in the 6540 running until the Maximum Sample Count is reached for each test that cannot satisfy the criteria set in Standard Deviation and Variance. In some cases it may be best to change the variance or the standard deviation from the system default values.

System Default Values:

	Variance	Standard Deviation	Sample Size
2700 pF	5.00 (ppm)	2.50 (ppm)	30
270 pF	7.00 (ppm)	3.50 (ppm)	60
27 pF	10.00 (ppm)	5.00 (ppm)	100
1.0 V	3.00 (ppm)	1.25 (ppm)	60
0.1 V	12.00 (ppm)	5.00 (ppm)	100

Maximum Sample Count 3000 (global setting for each test)

4.9.2.3.4. Protection Resistor Reference Values

Reference Resistor Calibration Values					
Variance (PPM)	200.00				
Standard Deviation	100.00				
Sample Size	25				
Maximum Sample Count	1000				
<table border="1" style="width: 100%; text-align: center;"> <tr> <td>Edit</td> <td>Ok</td> <td></td> <td></td> </tr> </table>		Edit	Ok		
Edit	Ok				

Variance is the difference between the maximum and minimum reading in ppm. This is used to ensure that the reading has stabilized before calculating the calibration coefficient.

Standard deviation (ppm) is used to further ensure that the measurement is stable and within spec.

Sample Size is used to specify the number of measurements to be used for calculating the coefficients.

Maximum Sample Count is set to specify the total number of measurements to be taken before the process is interrupted.

It should be noted that the instrument may not reach a stable state if it is running in an environment which has climate fluctuations or high levels of electrical or other types of interference. This will result in the 6540 running until the Maximum Sample Count is reached for each test that cannot satisfy the criteria set in Standard Deviation and Variance. In some cases it may be best to change the variance or the standard deviation from the system default values.

System Default Values:

Variance	Standard Deviation	Sample Size
200.00 (ppm)	100.00 (ppm)	30
Maximum Sample Count		1000

4.9.3. Diagnostics

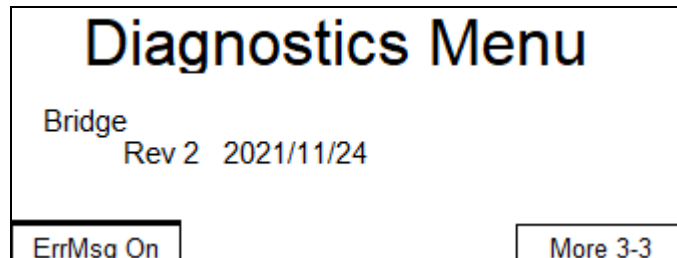
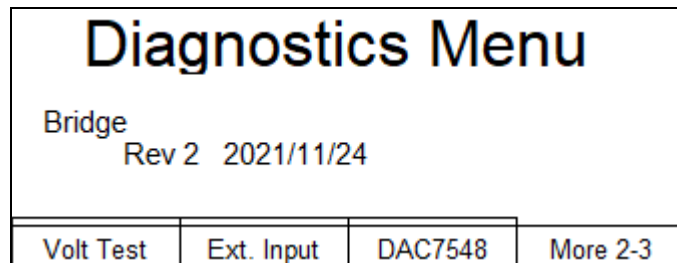
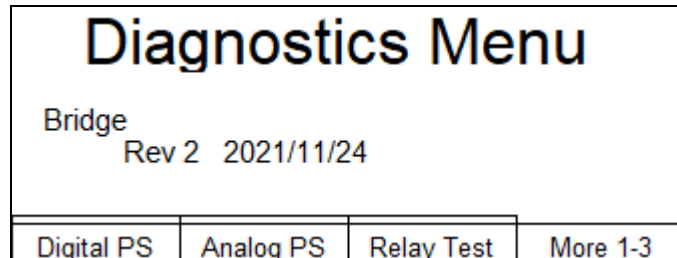

<ErrMsg Off> | <ErrMsg On> Disables/Enables on screen error messages.

The diagnostics section is used by the service technician to monitor voltage and to allow the testing of some of the input and outputs of the system.

4.9.3.1. Digital PS

Digital Power Supply			
+ 5 VOLTS	5.03	- 5 VOLTS	-4.93
+15 VOLTS	15.12	-15 VOLTS	-15.03
Internal Temperature 25.4 C			

The screen updates the values every 5 seconds.
Any key exits to Diagnostics Menu.

4.9.3.2. Analog PS

Analog Power Supply			
+ 5 VOLTS	5.03	- 5 VOLTS	-4.93
+15 VOLTS	15.12	-15 VOLTS	-15.03
PRECHARGE	-9.98	HV MON	-0.61
10V REF	9.98	RAMP	-12.15

The screen updates the values every 5 seconds.
Any key exits to Diagnostics Menu.

4.9.3.3. Relay Test

U800/J801 Test 1			
U704/J700	U800/J801	U900/J901	250 ms

This diagnostic tool requires a Guildline test jig and is only used by a qualified Guildline technician. It allows the monitoring of the digital outputs of the CPU board through the LED indicators on the test jig. An example of this is the source voltage relay controls (J801-9 – J801-15).

User selectable time delay between setting relays. 250 ms | 500 ms | 1 s | 2 s

4.9.3.4. Voltage Test

Output Voltage Source Test			
+1V			+50V
+2V			+100V
+5V			+200V
+10V			+500V
+20V			+1000V
Volts On	Negative	Direct	Rs Source

This is procedure requires the use of a DC Voltmeter.

Volts On/Volts Off turns the high voltage on/off.
 Polarity Positive | Negative
 Direct/Bridge shows the Mode
 Rs Source | Rx Source

4.9.3.5. External Input

External Input Monitor	
External Trigger - Disabled	
Interlock - Disabled	
Resistivity - Volume	
Exit	

This is used to check the status of external inputs. It can also be used to test the inputs. Interlock can be disabled from the Configure Menu.

4.9.3.6. DAC7548 Calibrate

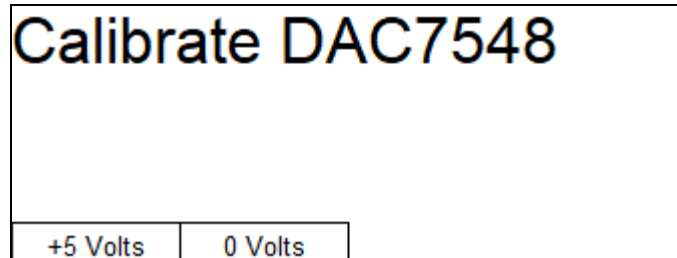

This is a factory calibration procedure for aligning the DAC7548 and is not part of the operational procedures.

4.9.4. Password

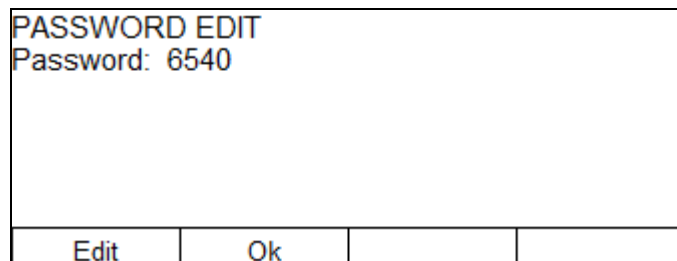

This is to allow the updating of the password. The system default password is 6540.

Enter the current password then press **<Ok>**.

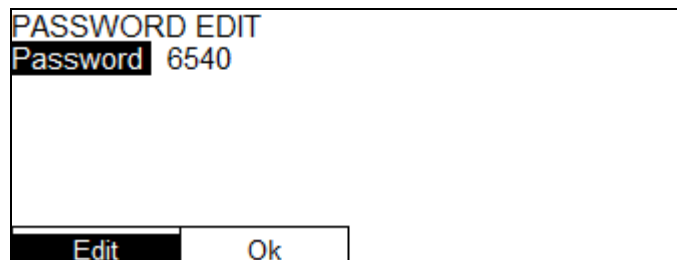

If the system is signed on with the correct password, then the system will prompt for the new password.

Enter the new password then press **<Ok>**.

<PREVIOUS> will return to the **Sofcal Menu**.

4.10. Menu System Hierarchy Diagrams

The menu system hierarchy used by the 6540 is outlined below. It has a separate section for Ohms, Current, Resistivity, Setup, and Calibrate.

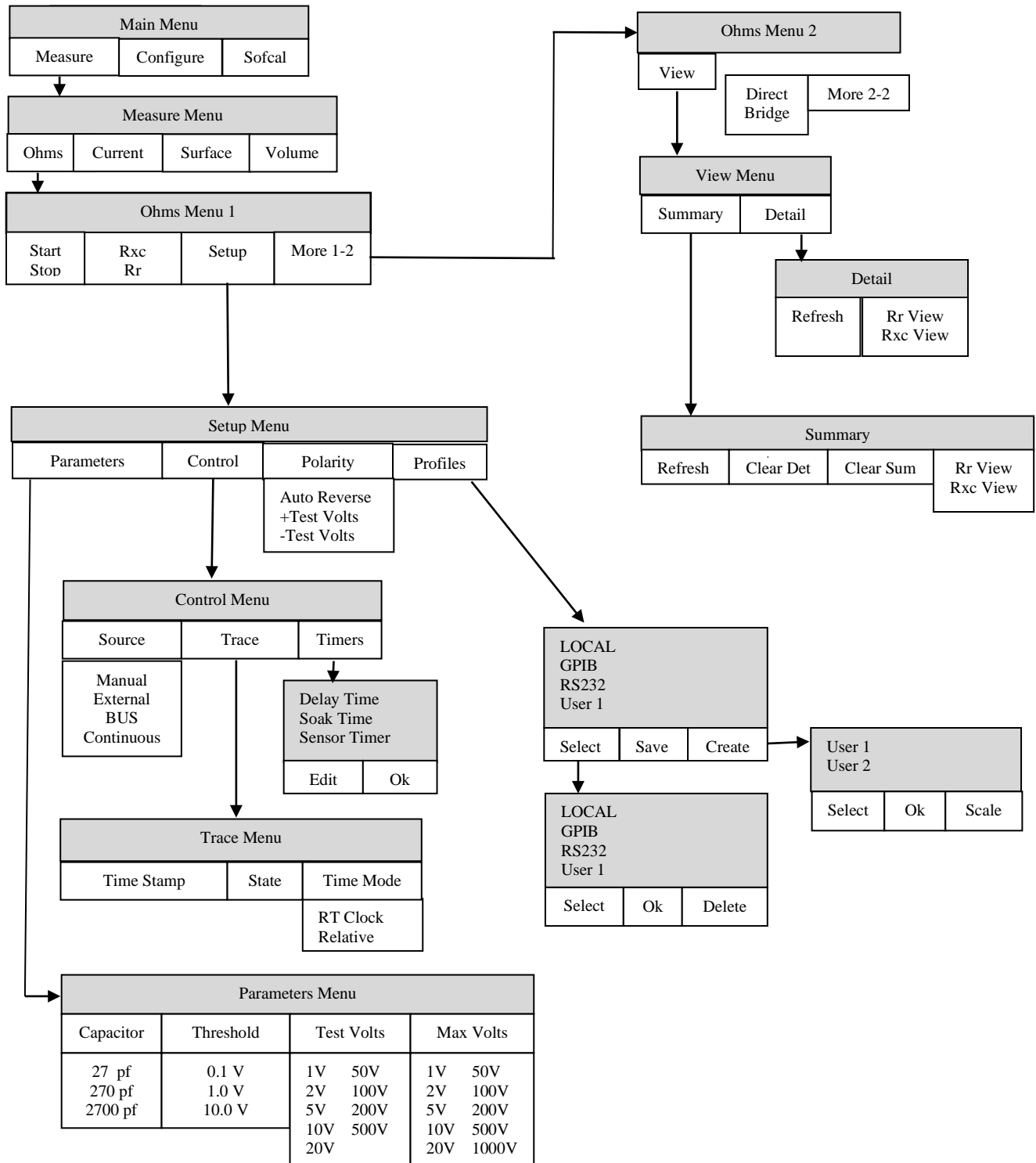

Figure 4-1: Ohms Hierarchy

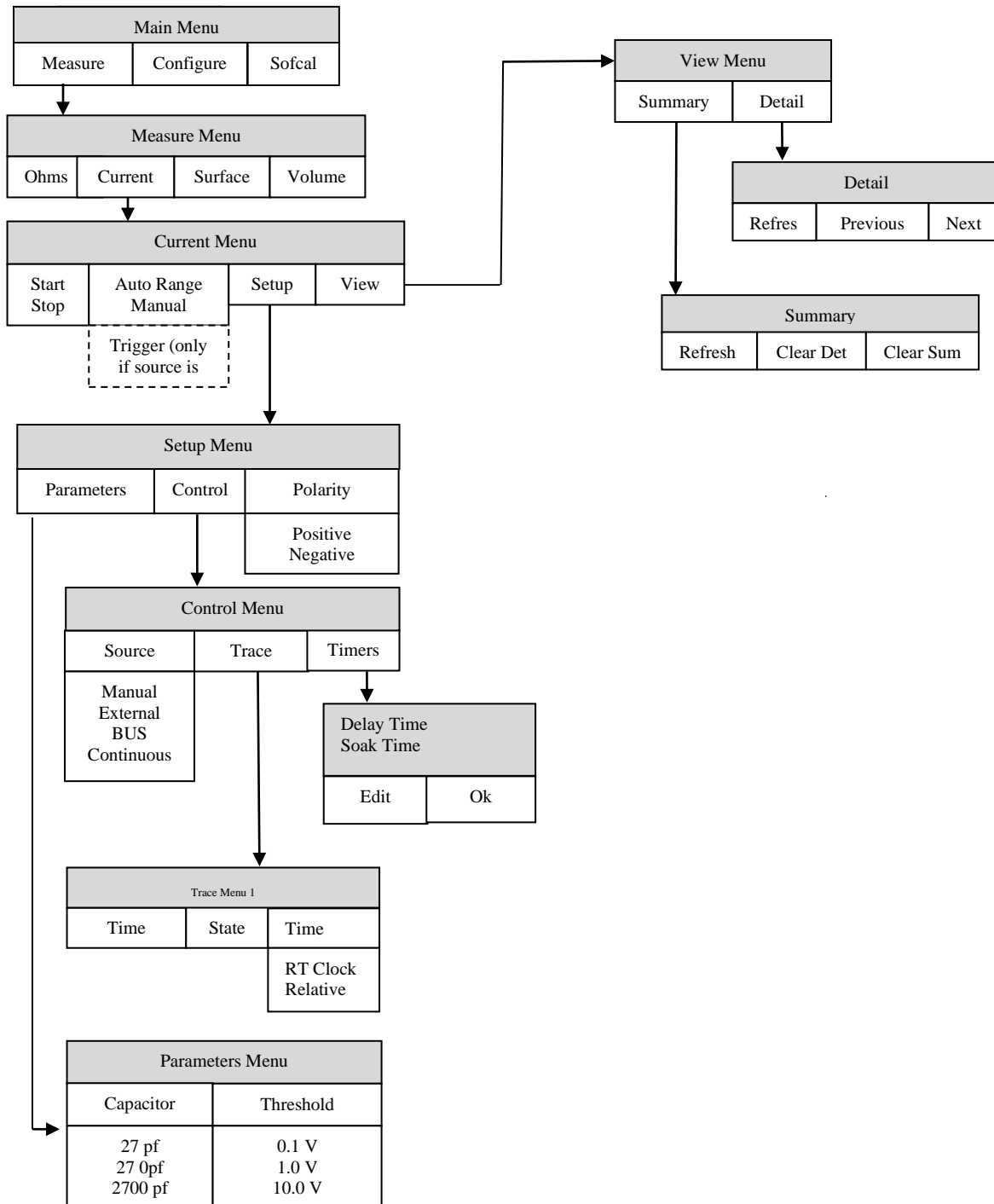

Figure 4-2: Current Hierarchy

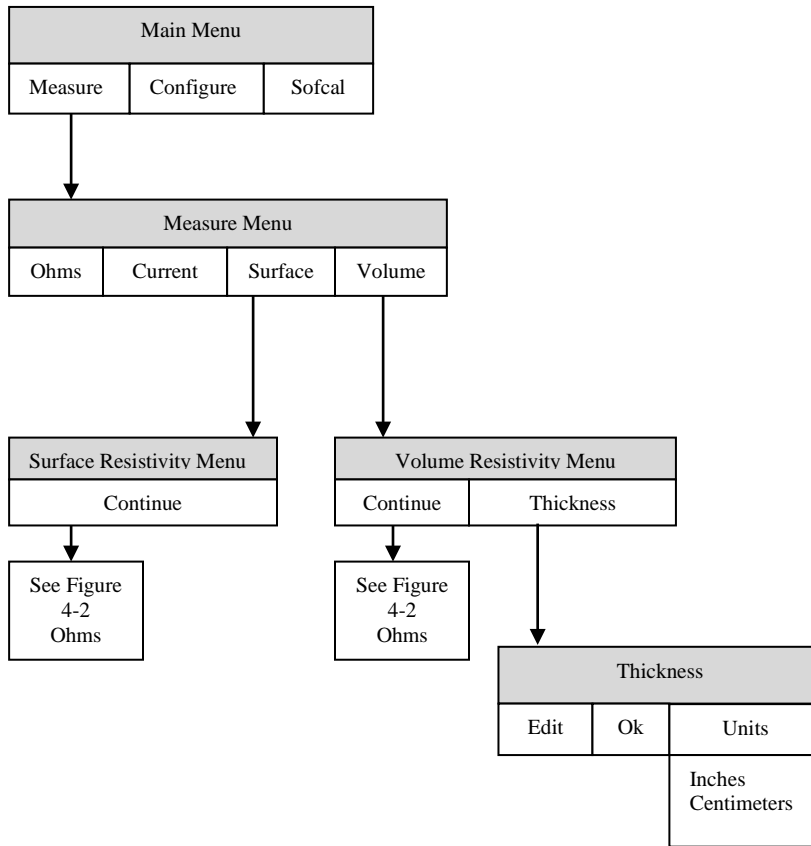

Figure 4-3: Resistivity Hierarchy

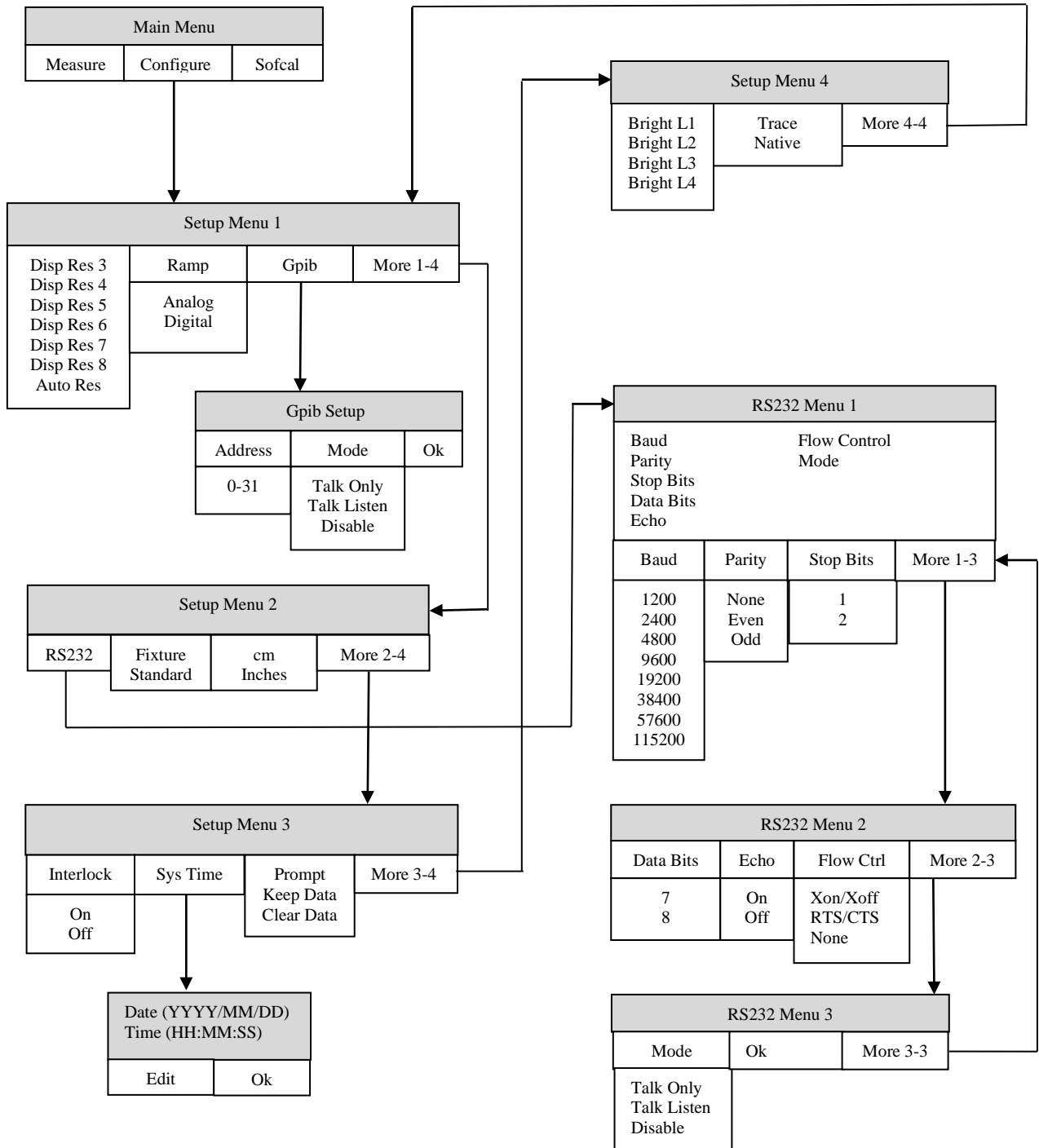

Figure 4-4: Setup Hierarchy

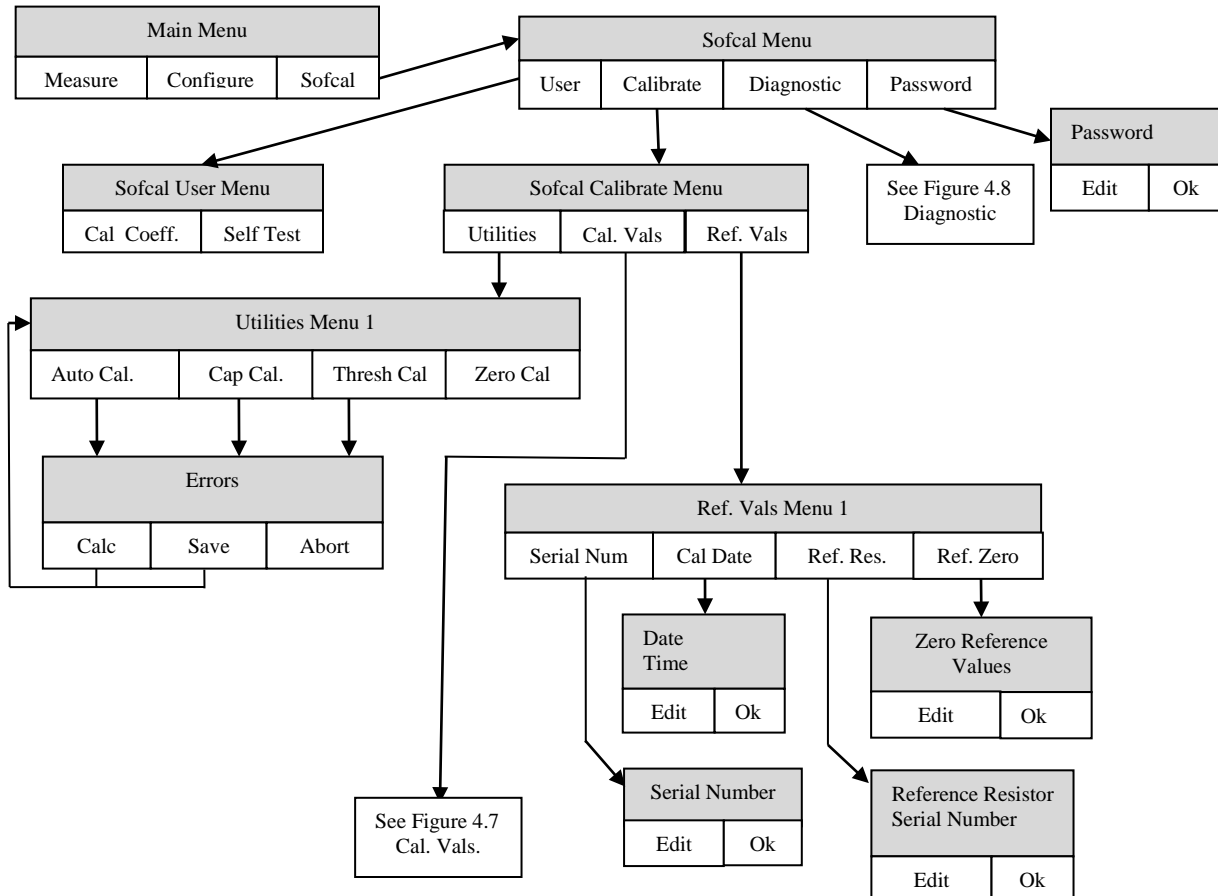

Figure 4-5: Sofcal Hierarchy

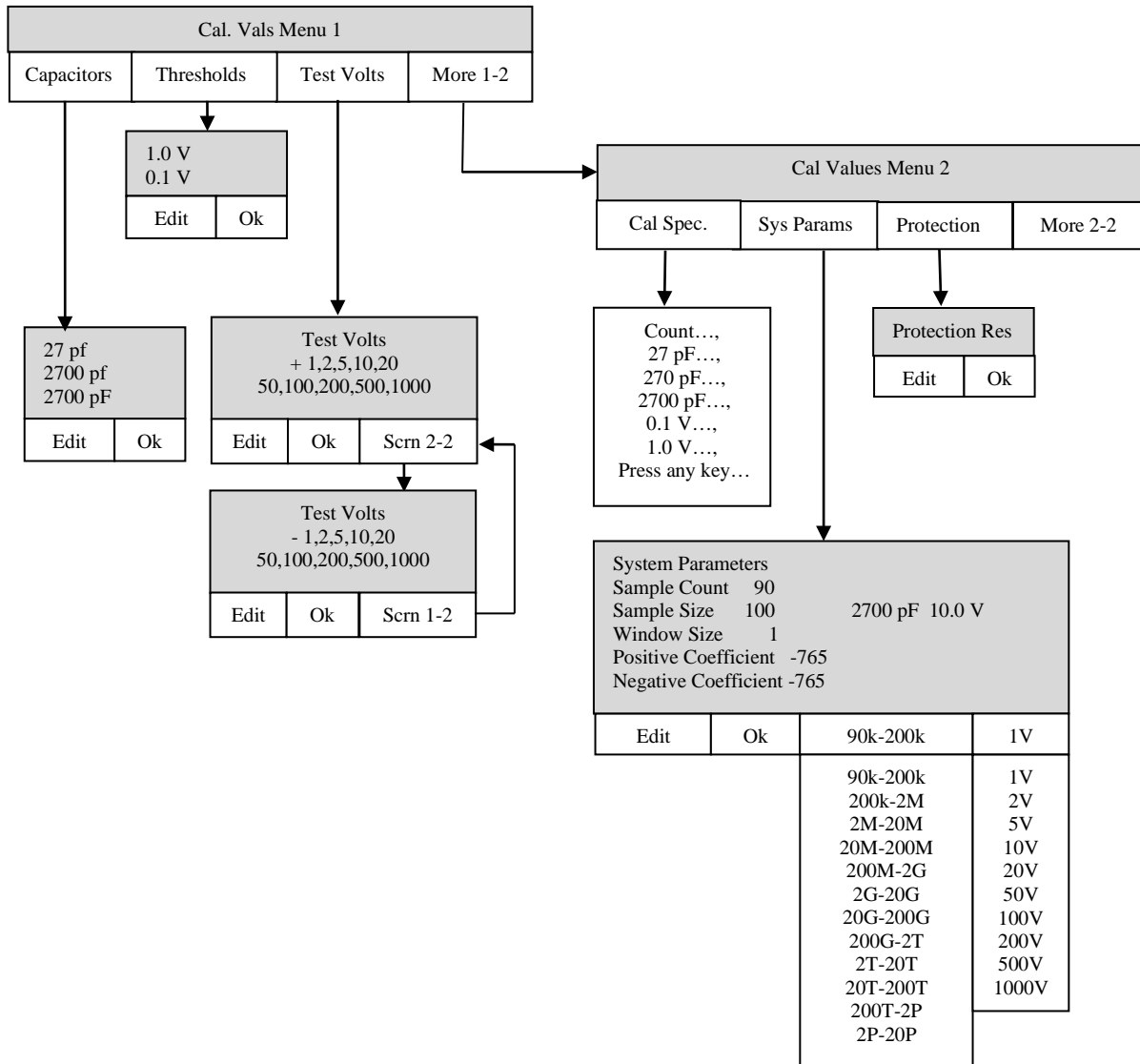

Figure 4-6: Sofcal Cal. Vals. Hierarchy

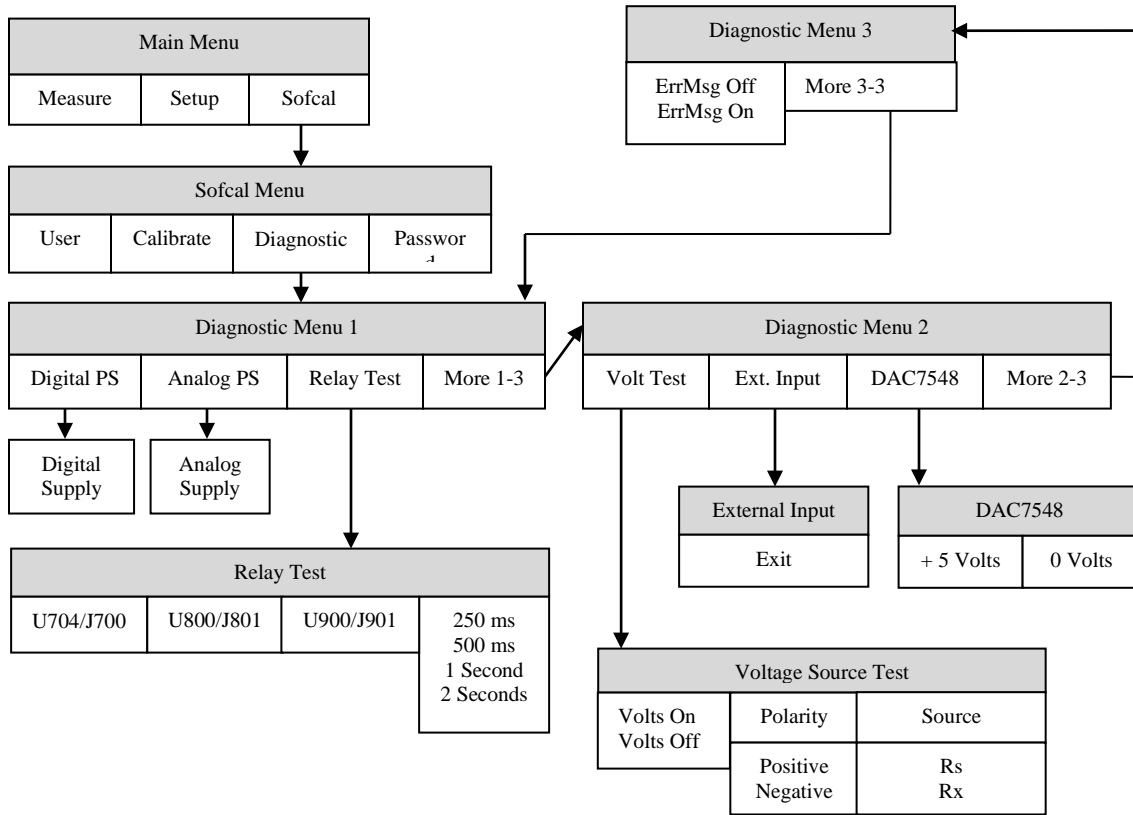

Figure 4-7: Sofcal Diagnostic Hierarchy

5. REMOTE CONTROL

The 6540 Dual Measurement High Resistance Bridge operates directly from the front panel or under remote control of an instrument controller, computer or terminal. Remote control can be interactive, with the user controlling each step from a terminal, or under the control of a computer running the 6540 in an automated system. It is also possible to connect a printer to the remote interface of the 6540 and have the 6540 output some or all of the measurements taken to the printer for a permanent record.

This chapter describes the interfaces and the commands to which the 6540 will respond. The setting of the IEEE-488 address and mode is described in OM6540 Section 5.8.1.

5.1. INTERFACES

The model 6540 has two interfacing standards available:

- A parallel interface conforming to IEEE-488.2.
- A serial interface conforming to RS-232C.

The IEEE-488 connector is mounted to the rear panel. The IEEE-488 address defaults to a factory setting of 04. This setting can be viewed and set to a valid address using the front panel controls.

The RS-232C connector is mounted on the rear panel but it has to be configured from the front panel.

The 6540 can be operated in a system where both RS-232C and IEEE-488 interfaces are being used. It can be controlled with an IEEE-488 bus and a printer connected to the RS-232C output for permanent records of measurements.

In a system containing more than one controller, only one controller can exercise control while the other stays in dormant state until control is transferred.

5.2. IEEE-488 (GPIB) INTERFACE

The 6540 is fully programmable for use on the IEEE standard 488.1 interface bus (also known as the General Purpose Interface Bus (GPIB)). The interface is also designed in compliance with the supplemental standard IEEE-488.2. Devices connected to the bus in a system are designated as talkers, listeners, talker/listeners, or controllers. The 6540 can be operated on the IEEE-488 bus as a talker or under the control of an instrument controller as a talker/listener.

This manual assumes that the user is familiar with the basics of the IEEE-488 interface bus. The IEEE-488 interfacing standard applies to the interface of instrumentation systems or portions of them, in which the:

1. Data exchanged among the interconnected apparatus is digital.
2. Number of devices that may be interconnected by one contiguous bus does not exceed 15.
3. Total transmission path length over interconnecting cables does not exceed the lesser of either 20 meters or 2 meters times the number of devices on the bus.
4. Data rate across the interface on any signal line does not exceed 1 megabit per second.

5.2.1. CONTROLLER

There can be only one designated controller in charge on the IEEE-488 bus. This device exercises overall bus control and is capable of both receiving and sending data. The rest of the devices can be designated as listener, talker or talker/listener.

The controller can address other devices and command them to listen, address one device to talk and wait till the data is sent. The controller sets data routes but it need not take part in the data interchange.

All controller query and command sequences should be terminated with the line-feed character (0x0A) and/or optionally; the controller should assert the EOI data byte control signal.

5.2.2. IEEE-488 RESPONSES

The reply to any IEEE-488 query command will be a sequence of ASCII characters followed by a line-feed character (0x0A). The line-feed character may also be expressed as 0A₁₆ or 10₁₀ or 12₈ or Ctrl-J. Throughout this manual we will use the "C" programming language notation for expressing numbers in base 16, specifically 0x0A indicates that 0A is to be interpreted in base 16 (hex).

5.2.3. INTERCONNECTING CABLE AND IEEE-488 CONNECTOR

The interconnecting cable of IEEE-488 1978 consists of 24 conductors, 16 conductors are for carrying signals and 8 for grounding. An individual cable assembly may be up to 4 meters long and should have both a plug and a receptacle connector type at each end of the cable. Each connector assembly is fitted with a pair of captive locking screws.

5.2.4. TYPICAL SYSTEM

Data Input/Output Lines - The 8 data I/O lines form the data bus over which data between the various devices is transmitted under the supervision of the controller. The message bytes are carried on Data I/O signal lines in a bit parallel byte serial form, asynchronously and generally in a bi-directional manner.

Handshake or Data Byte Control - the three interface signals are used to effect the transfer of each byte of data on the DIO signal lines from a talker or controller or one or more listeners.

1. DAV (DATA VALID) is used to indicate the condition of (availability and validity) information on the DIO signal lines.
2. NDAC (NOT DATA ACCEPTED)
3. NRFD (NOT READY FOR DATA) is used to indicate the condition of readiness of devices to accept data.
4. SRQ (SERVICE REQUEST) is used by a device to indicate the need for attention and to request an interruption of the current sequence of events.
5. REN (REMOTE ENABLE) is used (by a controller) in conjunction with other messages to select between two alternate sources of device programming data.
6. EOI (END OR IDENTIFY) is used (by a talker) to indicate the end of a multiple byte transfer sequence or in conjunction with ATN (by a controller) to execute a polling sequence.
7. ATN (ATTENTION)
8. IFC (INTERFACE CLEAR)

5.2.5. ADDRESS AND TALK/LISTEN SELECTION

The IEEE-488 Address and Talk/Listen status can be set using the front panel controls as directed by the operator menu system. If there is no controller and the 6540 is hooked up to a printer for hard copy then Talk Only mode should be selected as the preferred mode of operation.

5.2.6. IEEE-488 ELECTRICAL INTERFACE

The 6540 meets the subsets of the IEEE-488 interface specification IEEE-488.1 shown in Table 5-1. The pin connections on the IEEE-488 interface connector are shown in Table 5-2.

Pin Connection	Name	Function
Source Handshake	SH1	complete source handshake capabilities.
Acceptor Handshake	AH1	complete acceptor handshake capabilities.
Talker	T5	has a talker capability with a single primary address in the range 0 to 30. Extended addressing is not implemented. Talk only.
Listener	L4	supports basic listener with unaddressed if MTA(My Talk Address) is received. The talk and listen addresses will always be the same. Does not support extended listen addresses. Does not support Listen Only.
Service Request	SR1	complete service request generation capabilities.
Remote Local	RL1	all functions on the front panel can be locked out by the IEEE-488 controller.
Parallel Poll	PP0	no parallel poll capabilities.
Device Clear	DC1	full device clear capabilities.
Device Trigger	DT0	no device trigger capabilities.
Controller	C0	can never become the bus controller.
Electrical Interface	E2	all required electrical interface capability.

Table 5-1 : IEEE-488 Device Capabilities

Pin	Name	Description
1	DIO1	Data Input Output Line 1
2	DIO2	Data Input Output Line 2
3	DIO3	Data Input Output Line 3
4	DIO4	Data Input Output Line 4
5	EIO	End or Identify
6	DAV	Data Valid
7	NRFD	Not Ready for Data
8	NDAC	Not Data Accepted
9	IFC	Interface Clear
10	SRQ	Service Request
11	ATN	Attention
12	SHIELD	Screening on Cable (connected to safety ground)
13	DIO5	Data Input Output Line 5
14	DIO6	Data Input Output Line 6
15	DIO7	Data Input Output Line 7
16	DIO8	Data Input Output Line 8
17	REN	Remote Enable
18	GND6	Ground wire of twisted pair with DAV
19	GND7	Ground wire of twisted pair with NRFD
20	GND8	Ground wire of twisted pair with NDAC
21	GND9	Ground wire of twisted pair with IFC
22	GND10	Ground wire of twisted pair with SRQ
23	GND11	Ground wire of twisted pair with ATN
24	GND	Logic Ground

Table 5-2 : IEEE-488 Pin Designations

5.2.7. IEEE-488 INPUT BUFFERING

The IEEE-488 input buffer is 256 bytes long. The input full bit is set when the buffer is above 75% full (64 bytes remaining), hence if the programmer limits messages sent to the 6540 to 32 bytes and checks the IFL bit in the status register before sending each message, then under normal operating conditions the buffer should never overflow. If the buffer is full and the programmer sends more data, the 6540 will perform the necessary handshaking as per usual, but the data will be lost, this is done for two reasons:

If the buffer is full, the fault must have originated with the controller, since the 6540 interprets most commands in fewer than 15 milliseconds. This prevents the 6540 from locking up the IEEE-488 bus.

5.2.8. IEEE-488 OUTPUT BUFFERING

Output from query commands are placed into a 256 byte output buffer. When the controller reads data from the 6540 the responses will come from the output buffer in, first-in first-out order. If for some reason the controller does not read the responses from its query commands the output buffer will overflow, in this case the first data into the buffer will still be valid and the later data will be lost. When output data is lost the query

error bit in the status register will be set. When the output buffer is not empty then the message available (MAV) bit will be set in the status register.

5.2.9. IEEE-488 DEADLOCK

If the controller demands a byte of data from the 6540 and the buffer is empty, the 6540 will set the Query Error flag in the Event Status Register.

5.3. RS-232C INTERFACE

The 6540 has an RS-232C interface which can be connected to a controller or to a simple printer. The controller (which can be almost any computer with an RS-232C interface) can control the 6540 through a variety of commands that allow setting the instruments operating parameters, and analyzing the measurements made by the 6540. The simple printer interface can be used to log any or all of the measurements taken by the 6540 during normal operation.

When using the RS-232C port to remotely control the 6540, either interactively with a terminal or under computer control, operation is the same as using an IEEE-488 controller connected to the IEEE-488 port for control, with the following exceptions:

1. The program message terminator is Carriage Return (0x0D).
2. There is no SRQ capability when using serial remote control. The status registers still behave as described in this chapter, but the 6540 serial interface does not have a way to perform the SRQ function.
3. There is no direct way to perform IEEE-488 hardware interface functions such as DCL (Device Clear) or SDC (Selected Device Clear).

Pin	Name	Function	Direction
1	CHG	Chassis Ground	IN/OUT
2	TxD	Transmit Data	IN
3	RxD	Receive Data	OUT
4	RTS	Request To Send	IN
5	CTS	Clear To Send	OUT
6	DSR	Data Set Ready	OUT
7	GND	Signal Ground	IN/OUT
8	DCD	Data Carrier Detect	OUT
20	DTR	Data Terminal Ready	IN
All other pins not used or connected			

Table 5-3 : RS232 Pin Designations

The 6540 Dual Measurement High Resistance Bridge is data communication equipment (DCE) so TxD is an input (the data which the modem is to transmit).

5.3.1. RS-232C RESPONSES

The reply to any RS-232C query command will be a sequence of ASCII characters followed by a Carriage-Return character (0x0D) and then a Line-Feed character (0x0A). The Line-Feed character may also be expressed as 0A₁₆ or 10₁₀ or 12₈ or Ctrl-J. Throughout this document we will use the "C" programming language notation for expressing numbers in base 16, specifically 0x0A indicates that 0A is to be interpreted in base 16 (hex).

5.4. COMMAND LANGUAGE

The commands for IEEE-488 and RS-232C mainly correspond to the labels assigned to the front panel menus. Throughout this document, when examples are given, they apply to commands through the RS-232C interface or through the IEEE-488 interface. The examples will not show the termination characters since these differ for each of the interfaces (See Sections 5.2.2 and 5.3.1).

5.4.1. GENERAL SYNTAX FOR COMMANDS

The 6540 uses a sophisticated command parser which can usually determine which command was desired, even if the command is entered incorrectly. Some care should be taken when sending commands such as SYSTem:VERBose and SYSTem:VERSion? Since the parser may not be able to decide which command was desired in the event of a gross misspelling (such as using VERBion instead of VERSion).

No command used in the 6540 has an embedded space in its name; spaces (0x20) are used only to separate command names from their parameters.

The comma "," must delimit all multiple arguments used in a command sequence. Throughout this manual some of the command names will have an UPPER case portion and a lower case portion. The command may be shortened such that only the portion of the command name that was presented in UPPER case characters is present. The command parser of the 6540 is case insensitive (i.e. the letter case of commands sent to the 6540 does not matter), both UPPER case letters and lower case letters may be used.

5.4.2. GENERAL SYNTAX FOR NUMBERS

Numeric parameters may have up to 30 characters, and although the 6540 will accept numeric parameters in the range $\pm 2.2\text{E}-308$ through $\pm 1.8\text{E}308$, the useful range of numbers is between $\pm 1.0\text{E}-8$ and $\pm 1.0\text{E}5$.

The portion of the command parser that interprets numeric input will correctly recognize most common forms of numeric input, for example the following are all valid methods of expressing the number 123.4:

- 123.4
- 123.4e00
- 0.1234E3
- 1234e-1
- 0000123.4

The following are examples of invalid forms of expressing a number:

- 123.4 e00 space between mantissa and exponent letter
- 1234D-1 exponent not e or E
- n123.4 letter in front of the first digit
- e34 missing mantissa

Multipliers (such as μ , m, k, and M) are not permitted on commands, all numbers must be entered in the base units, for example 100 mV can be expressed as 100e-3 or 0.100. Expressions (for example $7 + 20 \times 3$) are not allowed as parameters.

5.4.3. REMOTE AND LOCAL OPERATION

The 6540 can be operated using the front panel keys or it can be operated remotely using a remote controller.:

5.4.4. LOCAL

The 6540 responds to local and remote commands. This is also called "Front Panel Operation". Only remote commands that do not affect the state of the 6540 are allowed to execute. (For example the command `SENSe:CAPacitor?` is allowed to operate but the command `SENSe:CAPacitor 27` which would change the instrument state is not allowed.) If the controller sends a command which would affect the instrument state while in local, the command will be ignored, and an Execution Error indication will be given.

5.4.5. REMOTE

When the Remote Enable (REN) line is asserted and the controller addresses the 6540 as a listener, the 6540 enters the remote state.

Front panel operation is restricted to the use of the <remote> key. Pressing the <remote> key or sending the GTL (Go To Local) interface message returns the 6540 to the local state.

5.4.6. REMOTE WITH LOCKOUT

The remote with lockout state can be entered from remote or local with lockout, but not directly from local. Remote with lockout is similar to the remote state but restricted: the <remote> key will not return to the local state. To return the 6540 to the local state the controller must send a GTL interface command. To return the 6540 to the local state the controller must unassert the REN control line. Table 5-4 summarizes the possible Remote/Local state transitions.

From	To	IEEE-488 Interface Command	RS-232C Interface Command
Local	Remote	MLA + REN	REMOTE
	Remote / Lockout	LLO + REN	LOCKOUT
Remote	Local	GTL	LOCAL
	Remote / Lockout	LLO + REN	LOCKOUT

Table 5-4 : Remote/Local State Transitions

5.5. PROGRAMMING COMMAND SUMMARY

A brief description of each of the possible remote RS232 and IEEE-488 commands and their syntax in BNF (Backus Naur Form) follows:

- words inside angle brackets (i.e. <digit>) are defined items
- ::= means "is defined to be"
- {} means "or"
- words inside square brackets (i.e. [+]) means optional
- Required letters are shown in upper case but may be upper or lower case.

<d>	::= {0 1 2 3 4 5 6 7 8 9}	
<l>	::= {A B C ... Z a b c ... z}	
<s>	::= {<l> <l><s>}	
	::= {0 1}	
<u>	::= {<d> <d><u>}	
<n>	::= [{+ -}]<u>	
<f>	::= <n>.[.<u>][E<n>]	
<?>	::= {<l> <d>}	
<*>	::= {<?> <?><*>}	(not to be confused with *)
<DD>	::= <u>	(limited to range 1...31)
<MM>	::= <u>	(limited to range 1...12)
<YYYY>	::= <u>	(limited to ranges 0...38 and 2000...2038)
<hh>	::= <u>	(limited to range 0...23)
<mm>	::= <u>	(limited to range 0...59)
<ss>	::= <u>	(limited to range 0...59)

SCPI Specification for 6540

5.5.1. Standard System Commands

*CLS	; clear event status register, empty input queue
*ESE <enable value (no units)>	; clear event status register, empty input queue
*ESE?	; report event status enable
*ESR?	; report event status register
*IDN?	; report identity of unit
*OPC	; set operation complete bit in event status register
*OPC?	; report operation complete
*OPT?	; report any reportable options
*RST	; reset the instrument to a known defined state
*SRE <enable value (no units)>	; set the service request mask
*SRE?	; report service request mask
*STB?	; report status byte
*TRG	; trigger the next reading when in BUS mode
*TST?	; report results of self test
*WAI	; wait for pending operations to complete

System Commands

SYSTem:BRIDGE <value> 1=BRIDGE MODE | 0=DIRECT MODE
:BRIDGE?

SYSTem:CHECK:SUM?

SYSTem:COMMunications:GPIB <address>, TALK Only | TALK Listen | DISable
address 0-31
:GPIB?

SYSTem:COMMunications:SERial <baud>, <data>, <stop>, <parity>, <echo>,
<flow control>, <mode>

baud 1200 | 2400 | 4800 | 9600 | 19200 | 38400

databits 7 | 8

stop 1 | 2

parity NONE | ODD | EVEN

echo ON | OFF

flowcontrol NONE | XON | RTS

mode TALK Only | TALK Listen | DISable

:SERial?

SYSTem:DATE <YYYY, MM, DD>
:DATE?

SYSTem:KEY?

SYSTem:MODE NATIVE | TRACE
:MODE?

SYSTem:STATE LOCAL | REMote | LOCKout
:STATE?

SYSTem:SERial:NUMBER <value>
:SERial:NUMBER?

SYSTem:TIME <hh,mm,ss>
:TIME?

SYSTem:TERSe

SYSTem:VERBoSe

SYSTem:VERSiOn?

5.5.2. Calibration Commands

CALibration:CAPacitor 27 | 270 | 2700 , <calibration coefficient (ppm)>
:CAPacitor?

CALibration:DATE <yyyy,mm,dd,hh,mm,ss>
:DATE?

CALibration:OUTPut:VOLTage +1 | +2 | +5 | +10 | +20 | +50 | +100 | +200 | +500 | +1000 |
-1 | -2 | -5 | -10 | -20 | -50 | -100 | -200 | -500 | -1000 ,
<calibration coefficient (ppm)>
:OUTPut:VOLTage?

CALibration:PARAmeters:PROTection <variance (ppm)> , <standard deviation (ppm)> ,
<sample size> , <maximum sample count>
:PARAmeters:PROTection?

CALibration:PARAmeters:RESistor
<variance (ppm)> , <std dev (ppm)> , <sample size> , ; 27pF
<variance (ppm)> , <std dev (ppm)> , <sample size> , ; 270pF
<variance (ppm)> , <std dev (ppm)> , <sample size> , ; 2700pF
<variance (ppm)> , <std dev (ppm)> , <sample size> , ; 0.1V
<variance (ppm)> , <std dev (ppm)> , <sample size> , ; 1.0V
<maximum sample count>
:PARAmeters:RESistor?

CALibration:PROTection:RESistor <value> ; 80K – 120K
:PROTection:RESistor?

CALibrate:RATIO:COEFFicient <index (Rs)>, <1:1 ratio coefficient>, <10:1 ratio coefficient >, <100:1 ratio coefficient > ;index=0-11 for 100k through 10P respectively
 :RATIO:COEFFicient? < index (Rs)>

CALibration:REFerence:RESistor <value> ; 80M - 12G
 :REFerence:RESistor?

CALibration:SERial:NUMBER <string> ; maximum length is 20
 :SERial:NUMBER?

CALibration:SPEC:CLEar

CALibration:SPEC?

CALibration:THReshold:VOLTage 0.1 | 1.0, <calibration coefficient (ppm)>
 :THReshold:VOLTage?

CALibrate:SYSTem:COEFFicient <nominal value>, <volts>, <pos coefficient>, <neg coefficient>
 :SYSTem:COEFFicient? <nominal value>, <volts>

CALibrate:SYSTem:PARAmeters <nominal value>, <volts>, <sample count>, <sample size>, <sample window>
 :SYSTem:PARAmeters? <nominal value>, <volts>

5.5.3. Configuration Commands

CONFigure:TEST:VOLTage START | CONTInue | DISable

5.5.4. Measurement Commands

MEASure ON | OFF
 MEASure?

MEASure:KNOWN <value> ; calibrated Rs value
 MEASure?

MEASure:UNITs OHMS | AMPS | SURFACE resistivity | VOLume Resistivity
 :UNITs?

MEASure:WINDow <value> ; MEAS:REV:COUNT * 2
 :WINDow?

MEASure:REVersal:COUNT REVersal:COUNT?	<value>	; 1 – 50 if MEAS:WINDOW > 0 else > 0
MEASure:TERA:COUNT TERA:COUNT?	<value>	; 0 – 500
MEASure:TERA:SIZE MEASure:TERA:SIZE?	<value>	; MEAS:TERA:COUNT - 2
MEASure:TERA:THReshold :TERA:THReshold?	<value>	; 0.0 – 0.9e+15
MEASure:STABilize:SIZE :STABilize:SIZE?	<value>	; 0 – 100
READ:RESistance?		;Ohms in direct mode
READ:VALUES?		;Ohms in bridge mode
READ:CURREnt? :SURface:RESistivity? :VOLume:RESistivity?		
SENSe:CAPacitor :CAPacitor?	27 270 2700	
SENSe:INTegration:TIME?		
SENSe:INTegrator:THReshold :THReshold?	0.1 1.0 10.0	
SENSe:MAXimum:VOLTage :VOLTage?	1 2 5 10 20 50 100 200 500 1000	
SENSe:OUTput:VOLTage :VOLTage?	1 2 5 10 20 50 100 200 500 1000	
SENSe:POLarity :POLarity?	POSitive NEGative AUTO	
SENSe:RANGe :RANGe?	AUTO MANual	
SENSe:REMote:INTerlock	ON OFF	

SENSe:REMOte:INTerlock?

SENSe:RESistivity:THICkness <value>
:THICkness?

SENSe:RESistivity:AREA <value>
:AREA?

SENSe:RESistivity:PERimeter <value>
:PERimeter?

SENSe:RESistivity:DISTance <value>
:DISTance?

5.5.5. Trace Commands

TRACe:CLEar

TRACe:DATA? ; dump buffer

TRACe:DIAGnostics ON | OFF | SENSORS
:DIAGnostics?

TRACe:ELEMents TIMEstamp, NONE , ALL , RELative Time , RTClock
:ELEMents?

TRACe:MODE CLEAR | PROMPT | KEEP
:MODE?

TRACe:TREND:DATA? ; dump summary buffer

TRACe:TREND:SUM? ; dump summary statistics

TRACe:TREND:CLEar ; clear summary statistics

TRACe:TSTamp:TYPE RELative | RTClock
:TSTamp:TYPE?

5.6. REMOTE COMMANDS

This section details all the valid commands that may be sent over either the IEEE-488 or the RS-232C interface port. The responses listed below are the verbose response.

If the numeric parameter to the command is missing or unrecognizable the CME (CoMmand Error) bit in the Event Status Register (see Figure 5-1) will be set. If the unrecognizable command was sent over the RS-232C interface, the 6540 will respond with “Unrecognized Command”.

If the numeric value is out of range, then the EXE (EXecution Error) bit will be set for a program data element out of range error. If the out of range value was sent over the RS-232C interface, the 6540 will respond with “Invalid Parameter”.

Unless otherwise indicated, the terse response is that portion of the response printed in bold.

5.6.1. ***CLS - CLEAR STATUS COMMAND**

This command clears all Event Status Registers summarized in the status byte register. All queues, except the Output Queue, that are summarized in the status byte register are emptied. The 6540 is forced into the Operation Complete Idle State and the Operation Complete Query Idle state.

5.6.2. ***ESE <u> - SET EVENT STATUS ENABLE REGISTER**

This command sets the standard event status enable register bits. When the bits in the Event Status Enable (ESE) register are "ANDed" with the bits in the Event Status Register (ESR) if the result is non-zero then the Event Status Bit (ESB) in the Status Byte (STB) register is set.

The values accepted for the *ESE command are between 0 and 255, all other values are considered to be an error. The default value for the Event Status Enable (ESE) register at power on is zero (0).

5.6.3. ***ESE? - EVENT STATUS ENABLE QUERY**

This command reports the current value of the Event Status Enable Register. The value returned will be between 0 and 255.

5.6.4. ***ESR? - EVENT STATUS REGISTER QUERY**

This query allows the programmer to determine the current contents of the event status register. Reading the Event Status Register clears it.

Bit	Location	Name	Description
0	LSB	OPC	Operation Complete. This event bit is generated in response to the *OPC or *OPC? command. It indicates that the 6540 has completed any pending operations and that the parser is ready to accept more program messages.
1		RQC	ReQuest Control. This event bit indicates to the GPIB controller that the 6540 is requesting permission to become the controller in charge. The 6540 will never set this bit.
2		QYE	QuerY Error. This bit indicates that an attempt is being made to read data from the output queue when no output is either present or pending, or that data in the output queue has been lost (queue over-flow). See also GPIB Deadlock.
3		DDE	Device Dependent Error. Not Used.
4		EXE	EXecution Error. Set when (1)a program data element is evaluated to be outside the legal input range or is inconsistent with the 6540's capabilities, (2)a valid program message could not be properly processed.
5		CME	CoMmand Error. Set when (1)a syntax error has been detected by the parser, (2)a semantic error has occurred indicating that an unrecognized header has been received, (3)A Group Execute Trigger was entered into the input buffer inside a program message.
6		URG	User Request. Set when any key is depressed on the 6540 keyboard.
7	MSB	PON	Power ON. This bit is set after the 6540 is powered up.

Table 5-5 : Event Status Register

5.6.5. *IDN? - IDENTIFICATION QUERY

This command causes the 6540 to reply with an identification string. The identification string is built up of four (4) fields delimited by commas (.). The first field is the manufacturer (i.e. Guildline Instruments), the second field is the model (i.e. 6540), the third field is the serial number (i.e. 55065), and the final field is the firmware revision (i.e. E). A typical response might read:

Guildline Instruments, 6540, 55065, E

5.6.6. *OPC - OPERATION COMPLETE

This command will cause the 6540 to set the Operation Complete bit (bit 0) in the Event Status Register. Since the 6540 processes all commands sequentially, the operation complete bit will be set as soon as the command is parsed.

5.6.7. *OPC? - OPERATION COMPLETE QUERY

This query will place a numeric 1 in the output buffer indicating that all pending operations are complete.

5.6.8. *OPT? - REPORT AVAILABLE OPTIONS

This query command reports the presence or absence of various options. The format of the reply is a series of arbitrary ASCII response fields separated by commas. The 6540 will always report the value 0.

5.6.9. *RST - DEVICE RESET

This command is intended to return the 6540 to a known state, specifically a return to terse mode. This command will not affect the following:

1. The output queue.
2. The state of the IEEE-488 interface.
3. The selected address of the 6540.
4. The *SRE setting.
5. The *ESE setting.
6. Calibration data that affects device specifications.

The *RST command will perform the following actions:

Clear the key-press buffer.

Make remote responses terse.

Set the measurement units to degrees Celsius.

Set the measurement display to the Aux Channel.

*RST is a MANDATORY IEEE-488.2 command.

5.6.10. *SRE <u> - SERVICE REQUEST ENABLE COMMAND

The service request enable command allows the 6540 to generate a service request on the IEEE-488 interface under a limited set of conditions. The limitations on the conditions are defined by the numeric parameter following the *SRE command. The numeric parameter is a decimal integer in the range 0-255. The numeric parameter when expressed in base 2 (binary) represents the bit values of the Service Request Enable Register. For all bits (except bit 6) a bit value of one (1) indicates an enabled condition and a bit value of zero (0) represents a disabled condition. *SRE? is the companion query command.

5.6.11. *SRE? - SERVICE REQUEST ENABLE QUERY

This command allows a programmer to determine the current contents of the Service Request Enable Register. A decimal number between 0 and 63 or between 128 and 191 will be returned.

5.6.12. *STB? - STATUS BYTE QUERY

This command allows the programmer to read the status byte and master summary bits (shown in Table 5-6.).

Bit	Location	Name	Description
0	LSB	INT	Interlock status. 0=enabled, 1=disabled.
1		RDY	Reading complete.
2		min_max	Minimum/Maximum timeout error if set.
3		IFL	Input Full. This bit is set when the input queue is over 75% full and cleared when the queue drops below 25% full.
4		MAV	Message Available. This bit is set when the output queue is not empty.
5		ESB	Event Summary Bit. This bit is set when the result of a bitwise AND of the Event Status Enable register is not zero.
6		RQS	ReQuest for Service. This bit is set when the result of a bit-wise AND of the Status Byte Register and the Service Request Enable register is not zero.
7	MSB	RES	Resistivity Input. 0=volume, 1=surface.

Table 5-6 : Status Byte Register

The response from this command is a decimal integer in the range 0-255. This decimal integer when expressed in base 2 (binary) represents the bit values in the Status Byte Register. Note that the Master Summary Status bit and Not RQS is reported in bit 6.

The Status Byte Register can also be read with the Read Serial Poll hardware command on the IEEE-488 interface.

This Register can be read by Serial Poll or by the *STB? command.

5.6.13. *TST? - QUERY RESULTS OF SELF TEST

This command is intended to report the status of any self-tests performed by the 6540. If the 6540 passes all of its self-tests then the reply will be 0.

The possible failure codes are:

Error Status. Bit 0 – Non-Volatile checksum failure

Bit 1 – Rom checksum failure. Could be ROM/Aux ROM.

Bit 2 – Analog failure.

Bit 3 - +5 volts

Bit 4 - -5 volts

Bit 5 - +15 volts

Bit 6 - -15 volts

Bit 7 – Precharge

Bit 8 – High voltage monitor

Bit 9 – 10 volt reference

Bit 10 - Ramp

Bit 11 – Digital failure.

Bit 12 - +5 volts

Bit 13 - -5 volts

Bit 14 - +15 volts

Bit 15 - -15 volts

5.6.14. *WAI - WAIT-TO- CONTINUE COMMAND

This command is intended to suspend the execution of any further commands until all pending operations have been completed. Since the 6540 does not implement a new command until the last operation has been completed, this command has no effect. It is included in the list of remote commands because it is a mandatory IEEE-488.2 command.

5.6.1. SYSTem:BRIDGE – SET BRIDGE/DIRECT MODE

1 | 0

Where 1=bridge and 0=direct mode of operation.

5.6.2. SYSTem:BRIDGE? – DISPLAY BRIDGE/DIRECT MODE

Typical response: 1

5.6.3. SYSTem:CHECK:SUM? – DISPLAY CHECKSUMS

This command displays the ROM checksum, the AUX ROM checksum and the Non-Volatile SRAM checksum.

Typical response: 17574, -12954, 1065

5.6.4. SYSTem:COMMunications:GPIB – UPDATE GPIB CONFIG

<address>, <mode>

address0-31

mode TALK Only | TALK Listen | DISable

If Disable is selected then GPIB will not work until it has been enabled by the RS232 serial interface or the Instrument

5.6.5. SYSTem:COMMunications:GPIB?

Typical response: 4, Talk Listen

5.6.6. SYSTem:COMMunications:SERial

<baud>, <data>, <stop>, <parity>, <echo>, <flow control>, <mode>

baud 1200 | 2400 | 4800 | 9600 | 19200 | 38400 | 115200

databits 7 | 8

stop 1 | 2

parity NONE | ODD | EVEN

echo ON | OFF

flowcontrol NONE | XON | RTS

mode TALK Only | TALK Listen | DISable

Talk Only will output measurement values to the RS232 interface.

N.B. Use of this command from the remote RS232 interface will change the configuration immediately. This will require the Remote Communications package which you are using to also be reconfigured to comply with your changes.

5.6.7. SYSTem:COMMunications:SERial?

Typical response: 9600, 8, 1, None, On, None, Talk Only

5.6.8. SYSTem:DATE – UPDATE SYSTEM DATE

<YYYY, MM, DD>

YYYY (limited to ranges 0...38 and 2000...2038)

MM (limit range to 1...12)

DD (limit range to 1...31)

5.6.9. SYSTem:DATE? – DISPLAY SYSTEM DATE

Typical response: 2003, 08, 22

5.6.10. SYSTem:KEY? – DISPLAY LAST KEY STROKE

Typical response: 4, e, 2

5.6.11. SYSTem:MODE – SET SYSTEM MODE

NATIVE | TRACE

5.6.12. SYSTem:MODE? – DISPLAY SYSTEM MODE

Typical response: NATIVE

5.6.13. SYSTem:SERial:NUMBer – SET SYSTEM SERIAL NUMBER

<value>

value (limit range to 0...99999)

5.6.14. SYSTem:SERial:NUMBer? – DISPLAY SYSTEM SERIAL NUMBER

Typical response: 67630

5.6.15. SYSTem:STATe - UPDATE SYSTEM STATE

LOCAL | REMote | LOCKout

5.6.16. SYSTem:STATe? – DISPLAY SYSTEM STATE

Typical response: LOCAL

5.6.17. SYSTem:TERSe – SET SYSTEM TO TERSE

Set the system to only display data on responses. (no text description)

5.6.18. SYSTem:TIME – SET SYSTEM TIME

<hh, mm, ss>

hh (limit range to 0...23)

mm (limit range to 0...59)

ss (limit range to 0...59)

5.6.19. SYSTem:TIME? – DISPLAY SYSTEM TIME

Typical response: 15, 10, 20

5.6.20. SYSTem:VERSion? – DISPLAY SYSTEM VERSION

Typical response: 2

5.6.21. SYSTem:VERBoSe – SET SYSTEM TO VERBOSE

Set the system to display a text description of displayed responses.

5.6.22. CALibration:CAPacitor – UPDATE COEFFICIENT

27 | 270 | 2700 , <error coefficient (ppm)>

The error coefficient is a long integer and cannot exceed $\pm 100,000$.

5.6.23. CALibration:CAPacitor? – DISPLAY COEFFICIENTS

This will display all three (3) capacitors and their coefficients.

Typical response: 27pf, 21254 270pf, -9871, 2700pf, 12926

5.6.24. CALibration:DATE – UPDATE LAST CALIBRATION DATE

<YYYY, MM, DD, hh, mm, ss>

This is the date and time of the last calibration which was done on the instrument.

5.6.25. CALibration:DATE? – DISPLAY LAST CALIBRATION DATE

Typical response: 2003, 08, 21, 15, 30, 0

5.6.26. CALibration:OUTPut:VOLTage – UPDATE COEFFICIENTS

+1 | +2 | +5 | +10 | +20 | +50 | +100 | +200 | +500 | +1000 |
 -1 | -2 | -5 | -10 | -20 | -50 | -100 | -200 | -500 | -1000 |, <error coefficient (ppm)>

The error coefficient is a long integer and cannot exceed $\pm 100,000$.

5.6.27. CALibration:OUTPut:VOLTage? – DISPLAY COEFFICIENTS

Typical response:

-1 V, 1.000189
 -2 V, 2.000033
 -5 V, 5.000029
 -10 V, 9.999963
 -20 V, 19.9999
 -50 V, 50.0018
 -100 V, 500.0014
 -200 V, 200.0024
 -500 V, 299.9957
 -1000 V, 999.916
 +1 V, .999921
 +2 V, 1.999948
 +5 V, 5.000017
 +10 V, 9.999989
 +20 V, 19.99966
 +50 V, 50.0021
 +100 V, 99.9994
 +200 V, 199.9964
 +500 V, 499.9934
 +1000 V, 999.929

5.6.28. CALibration:PARAmeters:PROTection

<variance (ppm)> , ; 1.0 – 1000.0
 <standard deviation (ppm)> , ; 1.0 – 250.0
 <sample size> , ; 25 - 500
 <maximum sample count> ; ≥ 125

5.6.29. CALibration:PARAmeters:PROTection?

Typical response: 200.00 , 100.00 , 25 , 1000

5.6.30. CALibration:PARAmeters:RESistor

27 pF Capacitor

<variance (ppm)> , ; 1.0 – 1000.0
 <standard deviation (ppm)> , ; 0.01 – 250.0
 <sample size> , ; 25 – 500

270 pF Capacitor

<variance (ppm)> , ; 1.0 – 1000.0
 <standard deviation (ppm)> , ; 0.01 – 250.0
 <sample size> , ; 25 – 500

2700 pF Capacitor

<variance (ppm)> , ; 1.0 – 1000.0
 <standard deviation (ppm)> , ; 0.01 – 250.0
 <sample size> , ; 25 – 500

0.1 V Threshold

<variance (ppm)> , ; 1.0 – 1000.0
 <standard deviation (ppm)> , ; 0.01 – 250.0
 <sample size> , ; 25 - 500

1.0 V Threshold

<variance (ppm)> , ; 1.0 – 1000.0
 <standard deviation (ppm)> , ; 0.01 – 250.0
 <sample size> , ; 25 - 500

<maximum sample count> ; >= 125

5.6.31. CALibration:PARAmeters:RESistor?

Typical response: 3.00 , 0.75 , 100 , 7.00 , 2.00 , 60 , 3.00 , 1.50 , 30 , 7.00 , 2.00 , 100 , 2.00 , 0.75 , 60 , 3000

5.6.32. CALibration:PROTection:RESistor

<value> ; 80K – 120K

5.6.33. CALibration:PROTection:RESistor?

Typical response: 100083

5.6.1. CALibrate:RATIO:COEFFicient

<index (Rs)>, <1:1 ratio coefficient>, <10:1 ratio coefficient >, <100:1 ratio coefficient >

The index (Rs) will be a number 0 through 11 for 100k through 10P respectively for Rs, which is then followed with the 3 corresponding coefficients for 1:1, 10:1 and 100:1 ratios at the given Rs.

5.6.2. CALibrate:RATIO:COEFFicient?

<index (Rs)>

Typical response: 3,141,344,252

5.6.3. CALibration:REFerence:RESistor

<value> ; 80M - 12G

5.6.4. CALibration:REFerence:RESistor?

Typical response: 100001800

5.6.5. CALibration:SERial:NUMBER

<string> ; maximum length is 20

5.6.6. CALibration:SERial:NUMBER?

Typical response: 62153

5.6.7. CALibration:SPEC:CLEar

5.6.8. CALibration:SPEC?

Typical response:

```
"Date", "Coefficient", "Count", "Sample", "Variance", "Std
2005/03/31 05:03:12, 27pF, -22926,97,30,26.389,7.951, 0.0, 0.0, 0.0
2005/03/30 22:41:39, 27pF, -22908,111,30,21.759,6.067, 0.0, 0.0, 0.0
2005/03/31 04:36:20, 270pF,6298,88,30,21.991,5.333, 0.0, 0.0, 0.0
2005/03/30 22:10:54, 270pF,6345,93,30,13.519,3.062, 0.0, 0.0, 0.0
2005/03/31 04:08:42,2700pF,6951,142,30,4.528,1.216, 0.0, 0.0, 0.0
2005/03/30 21:41:42,2700pF,6972,76,30,3.245,0.972, 0.0, 0.0, 0.0
2005/03/31 05:32:57, 0.1V,161,30,30,117.470,35.551, 0.0, 0.0, 0.0
2005/03/30 23:27:34, 0.1V,150,44,30,114.250,33.791, 0.0, 0.0, 0.0
2005/03/31 05:24:35, 1.0V,1,68,30,19.678,5.378, 0.0, 0.0, 0.0
2005/03/30 23:15:18, 1.0V,-4,107,30,16.896,4.242, 0.0, 0.0, 0.0
```

5.6.9. CALibration:SYSTem:COEFFicient

<nominal value>, <volts>, <pos coefficient>,>, <neg coefficient>

5.6.10. CALibration:SYSTem:COEFFicient?

Typical response: 90k to 200k, 1V, 273,273

5.6.11. CALibration:SYSTem:PARAMeters

<nominal value>, <volts>, <sample count>, <sample size>, <sample average>,<sample window>

5.6.12. CALibration:SYSTem:PARAMeters?

Typical response: 90k to 200k, 1V, 90, 100, 1, 2

5.6.13. CALibration:SYSTem:REV

<user rev>

5.6.14. CALibration:SYSTem:REV?

Typical response: <user rev> / <system rev>

5.6.15. CALibration:THReshold:VOLTage

0.1 | 1.0 <calibration coefficient (ppm)>

5.6.16. CALibration:THReshold:VOLTage?

Typical response: 0.1V, 37, 1.0V, -160

5.6.17. CONFigure:TEST:VOLTage

START | CONTInue | DISable

When the system is in remote or lockout then it is necessary to send a <CONTInue> command within twenty (20) seconds when measuring resistance or resistivity. This is a safety precaution to prevent the high voltage section from remaining active when the remote controlling device is not in a known operating state.

5.6.18. MEASure – START/STOP MEASUREMENT

ON | OFF

This is used to start or stop a measurement from a remote device (RS232 or GPIB)

5.6.19. MEASure?

Typical response: Off

5.6.1. MEASure:KNOWN

<value>

This is where you set the known value of Rs so that the Rx value can be properly calculated.

5.6.2. MEASure:KNOWN?

Typical response: 100000026

5.6.3. MEASure:UNITS – SET CURRENT MEASUREMENT MODE

OHMS | AMPS | SURFACE resistivity | VOLume Resistivity

5.6.4. MEASure:UNITS? – DISPLAY MEASUREMENT MODE

Typical response: Ohms

5.6.5. READ:RESistance? – DISPLAY DIRECT READING RESISTANCE

Typical response: 1.13499232e+16

5.6.1. READ:VALUES? – DISPLAY BRIDGE MODE RESISTANCE

Typical response: 1.13499232e+16

5.6.2. READ:CURRent?

Typical response: 1.13499232e+16

5.6.3. READ:SURFace:RESistivity?

Typical response: 1.13499232e+16

5.6.4. READ:VOLume:RESistivity?

Typical response: 1.13499232e+16

5.6.5. SENSE:CAPacitor – SET CURRENT CAPACITOR

27 | 270 | 2700

5.6.6. SENSE:CAPacitor? – DISPLAY CURRENT CAPACITOR

Typical response: 2700pf

5.6.7. SENSE:INTEgration:TIME?

Typical response: 1.1036

This is the time in seconds that it took to take the last measurement.

5.6.8. SENSE:INTEGrator:THREShold

0.1 | 1.0 | 10.0

5.6.9. SENSE:INTEgrator:THREShold?

Typical response: 10.0V

5.6.10. SENSE:MAXimum:VOLTage

1 | 2 | 5 | 10 | 20 | 50 | 100 | 200 | 500 | 1000

5.6.11. SENSE:MAXimum:VOLTage?

Typical response: 1V

5.6.12. SENSE:OUTput:VOLTage

1 | 2 | 5 | 10 | 20 | 50 | 100 | 200 | 500 | 1000

5.6.13. SENSE:OUTput:VOLTage?

Typical response: 10V

5.6.14. SENSE:POLarity

POSitive | NEGative | AUTO

5.6.15. SENSE:POLarity

Typical response: Auto

5.6.16. SENSE:RANGe

AUTO | MANual

5.6.17. SENSE:RANGe?

Typical response: Auto

5.6.18. SENSE:REMote:INTerlock

ON | OFF

This will enable or disable the interlock function while controlling the 6540 remotely.

5.6.19. SENSE:REMote:INTerlock?

Typical response: ON

5.6.20. SENSE:RESistivity:THICkness

<value>

This is the thickness of the material being measured. It should be entered in either inches or centimetres depending on the current resistivity unit.

5.6.21. SENSE:RESistivity:THICkness?

Typical response: 0.125

5.6.22. SENSE:RESistivity:AREA

<value>

This is the area coefficient. It is normally zero (0) but can be set to another value if you are using the custom mode of measuring resistivity.

5.6.23. SENSE:RESistivity:AREA?

Typical response: 0.0

5.6.24. SENSE:RESistivity:PERimeter

<value>

This is the perimeter. It is normally set to 0.125 if unit is inches but can be set to another value if you are using the custom mode of measuring resistivity.

5.6.25. SENSE:RESistivity:PERimeter?

Typical response: 0.125

5.6.26. SENSE:RESistivity:DISTance

<value>

This is the distance. It is normally set to 0.125 if unit is inches but can be set to another value if you are using the custom mode of measuring resistivity.

5.6.27. SENSE:RESistivity:DISTance?

Typical response: 0.125

5.6.28. TRACe:CLEar – CLEAR DETAIL TRACE BUFFER

This will clear the detail trace buffer and the detail totals of the summary.

5.6.29. TRACe:DATA? – DUMP TRACE BUFFER

Typical response:

```
1.13499232e+16,2003/07/30 10:28:04,82, 22.1, 80.0, 101.0,27pf,0.1V,Auto,1000  
1.13953412e+16,2003/07/30 10:33:54, 5, 22.4, 80.1, 101.2,27pf,0.1V,Auto,1000
```

5.6.30. TRACe:DIAGnostics

ON | OFF

This is normally set to off. <On> provides a means to automatically output the Digital Diagnostics or the Analog Diagnostics to the remote device as well as the display while this diagnostic is running.

5.6.31. TRACe:DIAGnostics?

Typical response: Off

5.6.32. TRACe:MODE

CLEAR | PROMPT | KEEP

This is normally set to KEEP which will retain the data stored in the trace buffer upon the start of a new measurement. <CLEAR> provides a means to automatically clear the trace buffer upon the start of a new measurement. <PROMPT> will prompt the user upon the start of a new measurement asking to “Clear” or “Keep” the trace buffer data. While in remote this mode assumes “Keep”.

5.6.33. TRACe:MODE?

Typical response: Keep

5.6.34. TRACe:ELEMents

TIMEstamp, NONE , ALL , RELative Time , RTClock

5.6.35. TRACe:ELEMents?

Typical response: None

5.6.36. TRACe:TREND:DATA? – DUMP SUMMARY BUFFER

5.6.37. TRACe:TREND:SUM? - DUMP SUMMARY STATISTICS

5.6.38. TRACe:TREND:CLEAr – CLEAR SUMMARY STATISTICS

This will clear the summary trace buffer and the summary totals.

5.6.39. TRACe:TSTamp:TYPE

RELative | RTClock

This allows the time of each entry in the trace buffer to be displayed either as the date and time or as relative time from the last <TRACe:CLEAr> command or the last detail clear on the instrument.

5.6.40. TRACe:TSTamp:TYPE?

Typical response: RTClock

5.6.41. TRIGger:SOURce

MANual | BUS | EXTernal | CONTInuous

<BUS> is used if individual measurements wish to be controlled with the <*TRG> remote command.

5.6.42. TRIGger:SOURce?

Typical response: Continuous

5.6.43. TRIGger:DELay

<value> ; 0-999999.999 seconds

This allows the instrument to provide any internal delay between each measurement. It is normally set to zero (0) but is used to create a delay between measurements especially if they are very fast measurements.

5.6.44. TRIGger:DELay?

Typical response: 0.0

5.6.45. TRIGger:SOAK

<value> ; 0-999999.999 seconds

This allows the instrument to allow additional settling time between reversals of polarity.

5.6.46. TRIGger:SOAK?

Typical response: 0.0

6. VERIFICATION AND CALIBRATION

6.1. CALIBRATION DESCRIPTION

The procedure outlined in this section may be used to perform system verification of the 6540 Dual Measurement High Resistance Bridge for proper operation. This verification procedure may be performed when the instrument is first received to ensure that no damage or maladjustment has occurred during shipment.

6.1.1. ENVIRONMENTAL CONDITIONS

Verification checks should be made only when the instrument is being operated within the operating limits of temperature and humidity specified in Section 8 of this manual.

6.1.2. INITIAL CONDITIONS

A warm-up time of at least four hours must be allowed before beginning the verification process. If the instrument has been subjected to extremes of temperature outside the operating limits, additional time should be allowed for the instrument components to stabilize to their normal operating temperatures. Typically, it takes one additional hour to stabilize a unit that has been exposed to a temperature 10°C outside the specified temperature range.

6.1.3. RECOMMENDED TEST EQUIPMENT

Table 6-1 lists all test equipment required for the verification of the 6540 Dual Measurement High Resistance Bridge. Alternate equipment may be used as long as the substitute equipment has specifications as good as or better than the equipment listed.

Description	Minimum Use Specifications	Recommended Equipment
Output Voltage	Range (0 to ± 1000) DC V, accuracy $\pm 0.1\%$ of output	DC V Meter accuracy < 60 ppm or better, minimum 10 M Ω input impedance

Table 6-1: Recommended Verification Test Equipment

6.1.4. CHECK CALIBRATION REPORT

The following paragraph details the procedures to be used to check the stored calibration coefficients against the coefficients listed on the instrument calibration report. If the instrument has been re-calibrated or adjustments made to the instrument after the date printed on the calibration report, the stored coefficients may not match the coefficients listed in the report. The user should verify the instrument against the most recent calibration report.

6.1.4.1. CALIBRATION COEFFICIENTS

- Reference should be made to Section 6.5.2
- Apply power to the instrument
- Verify that the unit passes all self-tests
- Press the <SOFCAL> key
- Press the <Calibrate> key
- Press the <Ref Vals> key
- Press the <Serial Num> key
- Verify that the serial number displayed matches the serial number printed on the rear of the instrument and on the instrument calibration report.
- Press the <PREVIOUS> key to exit to the Calibrate menu
- Press the <PREVIOUS> key to exit to the Sofcal menu
- Press the <User> key to enter the User menu
- Press the <Err Coeff> key to enter the Error coefficients menu
- Verify the error displayed for each test voltage matches the value listed in the calibration report
- Verify the error displayed for the ZERO COEFFICIENT matches the value listed in the calibration report
- Verify the error displayed for the CAPACITOR COEFFICIENTS matches the values listed in the calibration report
- Verify the error displayed for the THRESHOLD COEFFICIENTS matches the values listed in the calibration report
- Press the <PREVIOUS> key to exit to the User menu
- Press the <PREVIOUS> key to exit to the Sofcal menu

6.1.5. TEST VOLTAGE VERIFICATION

Connect the Digital Voltmeter to the SOURCE connector of the 6540 under test.

Put the instrument into the SOFCAL DIAGNOSTIC MENU

Select <Volt Test> function key to perform Voltage Test.

Use the Up/Down arrow keys to select the +1 V test voltage.

Press the <Volts On> key to turn the SOURCE output on.

Record the reading displayed by the DC V Meter. Press the <Down Arrow> key to select the next test voltage. Record each test voltage nominal value (Vnom) and the DC V reading (Vdvm) for each test voltage (+1 V through +1000 V and -1 V through -1000 V). Press the <Volts Off> key to turn the SOURCE output OFF. Calculate the test voltage error value from the following expression:

$$\text{Error (ppm)} = \frac{V_{\text{dvm}} - V_{\text{report}}}{V_{\text{nom}}} \times 10^6$$

Use the absolute value of V_{dvm} and V_{report} . For each test voltage verify that the Error (ppm) does not exceed the ± 50 ppm of the listed value in the calibration report (Table 6-3).

6.1.6. OPERATIONAL CHECK

Performing an instrument Power On Reset and observing the response can check the operation of the 6540 Dual Measurement High Resistance Bridge display and indicators. The 6540 will respond as detailed in Section 4.2. Power “On” the instrument and observe that the instrument responds to the series of internal diagnostic checks as detailed in Section 4.2

6.2. CALIBRATION PROCEDURE

The procedure outlined in this section may be used to perform an Artifact Calibration on the 6540 Dual Measurement High Resistance Bridge to remove the effect of long term drift associated with capacitor and thresholds in the electrometer. This process ensures the base current measurement of the electrometer operates within the limits stated in the specifications (Section 8) of this manual. This calibration procedure should be executed on an annual basis as a minimum to maintain full rated 12 month accuracy when the 6540 is used for current measurements. A full resistance confirmation of the 6540 should be performed after the artifact calibration as this, DOES AFFECT THE RESISTANCE OPERATION, or whenever there is a question of instrument accuracy. Full performance confirmation and any subsequent adjustments, though recommended to be performed at the factory, may be performed by a qualified individual. These instructions can be obtained from Guildline Instruments Limited. A brief description of the Calibration and Instrument theory can be found in Section 6.4.

6.2.1. ENVIRONMENTAL CONDITIONS

Calibration of the instrument should only be performed while the 6540 is being operated within the operating limits of temperature and humidity specified in Section 8 of this manual.

6.2.2. INITIAL CONDITIONS

A warm-up time of at least one hour must be allowed before beginning the verification process. If the instrument has been subjected to extremes of temperature outside the operating limits, additional time should be allowed for the instrument components to stabilize to their normal operating temperatures. Typically, it takes one additional hour to stabilize a unit that has been exposed to a temperature 10 °C outside the specified temperature range.

6.2.3. RECOMMENDED TEST EQUIPMENT

Table 6-2 lists all test equipment required for the Artifact Calibration of the 6540 Dual Measurement High Resistance Bridge. Alternate equipment may be used as long as the substitute equipment has specifications as good as or better than the equipment listed.

Description	Minimum Use Specifications	Recommended Equipment
Output Voltage	Range (0 to ± 1000) DC V, accuracy $\pm 0.1\%$ of output	DC V Meter accuracy < 60 ppm or better, minimum 10 M Ω input impedance
Auto Calibration Capacitor coefficients	27 pF $\pm 200\,000$ ppm 270 pF $\pm 80\,000$ ppm 2700 pF $\pm 20\,000$ ppm	Guildline 9336 or 9334A 100 M Ω Reference Resistor, calibrated, max. Uncertainty 30 ppm
Auto Calibration Threshold coefficients	0.1 V ± 1000 ppm 1.0 V ± 1000 ppm	Guildline 9336 or 9334A 100 M Ω Reference Resistor, calibrated, max. Uncertainty 30 ppm
Short Circuit	0 ohm link	Guildline 65224
Input Current (optional)	Range (± 10 m to $\pm 10\mu$) DC A ± 200 ppm	Fluke 5700A or equivalent

Table 6-2: Recommended Calibration Test Equipment

6.2.4. OUTPUT VOLTAGE CALIBRATION

Connect the Digital Voltmeter to the SOURCE connector of the 6540 under test (use the MHV-M to BANANA PLUG cable P/N 30046-01-21). Attach the TRIAX to type N cable to the INPUT connector.

Put the instrument into the SOFCAL DIAGNOSTIC Menu (reference Section 4.9.3)

Select the +1 V test voltage

Press the <Volts On/Off> function key to turn SOURCE output on.

Allow sufficient time for the DVM reading to stabilize. Record the reading displayed by the DVM. Press the <DN> key to select the next test voltage. Record each test voltage reading (V_{dvm}) for each test voltage (+1 V through +1000 V and -1 V through -1000 V).

Press the <Volts On/Off> key to turn the SOURCE output OFF. For each test voltage record the actual voltage read.

- Press the <PREVIOUS> key to exit to the Sofcal Diagnostic Menu.
- Press the <PREVIOUS> key to exit to the Sofcal Menu.
- Select the <Calibrate> function key
- Reference Section 4.9.2.2
- Verify the unit is in the <Calibrate> Menu
- Select the <Ref. Vals> function key
- Verify the unit is in the <Reference> Menu
- Select the <Serial Number> key
- Verify that the Serial Number displayed matches the serial number printed on the rear of the instrument and on the calibration report.
- Press the <PREVIOUS> key to exit to the Sofcal Reference Menu.
- Press the <PREVIOUS> key to exit to the Sofcal Calibrate Menu.
- Select the <Cal. Vals> function key
- Verify the unit is in the <Calibrate> Menu
- Select the <Test Volts> function key
- Verify the display indicates all test voltages and their current error coefficient.
- Select the <Edit> function key
- Use the numeric keys to enter the new test voltage coefficients (in ppm) calculated previously.
- Carefully check the entered number then press the <Ok> key to accept and store the new coefficients.
- Press the <PREVIOUS> key to exit back to the Sofcal Calibrate Menu.

6.2.5. AUTO CALIBRATION

The Auto Calibration routine is a built in process in the 6540 that will calibrate all three capacitor and both threshold values with a single 100 M Ω traceable resistor. This process is an automatic sequencing of the Capacitor and Threshold Calibration routines which can be executed on an individual basis as described in Sections 6.2.6 and 6.2.7. To execute this process follow the steps below.

NOTE: This operation DOES change the coefficients and voids the previous calibration, both resistance and current. Upon completion the 6540 will have to verified across the operation range.

- Reference Section 4.9.2.1.1.
- Connect the 100 M Ω reference resistor between the SOURCE and INPUT terminals of the instrument.
- Select the SOFCAL CALIBRATE MENU by pressing the <Calibrate> function key when in the Sofcal Menu
- Press the <Ref Vals> function key.
- Press the <Ref Res> function key.

- Press the <Edit> function key.
- Using the numeric keys enter the new value of the reference resistor and its serial number
- New values for variance, standard deviation and sample size criteria for the 2700 pF capacitor may be entered using the numeric keypad if required (see Section 4.9.2.3.3)
- Repeat this process for the 270 pF and 27 pF capacitors, as well as the 1.0 V and 0.1 V thresholds.
- Press the <Ok> key to accept/store the new values.
- Press the <Cal Date> function key.
- Press the <Edit> function key to edit/re-enter the new calibration date.
- Press the <Ok> key to accept the new calibration date.
- Press the <PREVIOUS> key to exit back to the Sofcal Calibrate Menu.
- Press the <PREVIOUS> key to exit back to the Sofcal Calibrate Menu (top).
- Press the <Utilites> function key.
- Press the <Auto Cal.> function key.
- The 6540 will proceed to calibrate all three capacitor and the two thresholds.

Note: Ensure that the 100 M Ω reference resistor is connected. Press the <Auto Cal> key to start the automatic capacitor calibration sequence.

Note: When the calibration sequence is complete the instrument will prompt with the new calibration coefficient in the display window.

- The automated calibration sequence will run each measurement until it has satisfied variance and standard deviation requirements for the sample size of each test.
- If the requirements have not been met within the maximum retries the test is automatically stopped.
- If the test completes fully then acceptable results have been achieved. Press the <Save> key to save the results. This will update all capacitor coefficients and threshold coefficients.
- If the results are not acceptable then, you will need to return to the <Reference> Menu and adjust the test criteria to allow either more retries or a wider standard deviation/variance for the failed test.
- Press the <PREVIOUS> key to exit to the Sofcal Calibrate Menu.

6.2.6. CAPACITOR CALIBRATION

The Capacitor Calibration is a series of routines that are built in the 6540 to calibrate each of the three capacitors individually with the 100 M Ω traceable resistor. To execute this process follow the steps below.

NOTE: This operation DOES change the coefficients and voids the previous calibration, both resistance and current. Upon completion the 6540 will have to verified across the operation range.

- Reference Section 4.9.2.1.2.
- Connect the 100 M Ω reference resistor between the SOURCE and INPUT terminals of the instrument.
- Select the SOFCAL CALIBRATE MENU by pressing the <Calibrate> function key when in the Sofcal Menu
- Press the <Ref Vals> function key.
- Press the <Ref Res> function key.
- Press the <Edit> function key.
- Using the numeric keys enter the new value of the reference resistor and its serial number
- New values for variance, standard deviation and sample size criteria for the 2700 pF capacitor may be entered using the numeric keypad if required (see Section 4.9.2.3.3)
- Repeat this process for the 270 pF and 27 pF capacitors on XR and XPR Models.
- Press the <Ok> key to accept/store the new values.
- Press the <Cal Date> function key.
- Press the <Edit> function key to edit/re-enter the new calibration date.
- Press the <Ok> key to accept the new calibration date.
- Press the <PREVIOUS> key to exit back to the Sofcal Calibrate Menu.
- Press the <PREVIOUS> key to exit back to the Sofcal Calibrate Menu (top).
- Press the <Utilites> function key.
- Press the <Cap Cal.> function key.

Note: Ensure that the 100 M Ω reference resistor is connected. Press the <Calc> key to start the automatic capacitor calibration sequence.

Note: When the calibration sequence is complete the instrument will prompt with the new calibration coefficient in the display window.

- The automated calibration sequence will run each measurement until it has satisfied variance and standard deviation requirements for the sample size of each test.
- If the requirements have not been met within the maximum retries the test is automatically stopped.
- If the test completes fully then acceptable results have been achieved. Press the <Save> key to save the results. This will update all capacitor coefficients.
- If the results are not acceptable then, you will need to return to the <Reference> Menu and adjust the test criteria to allow either more retries or a wider standard deviation/variance for the failed test.
- Press the <PREVIOUS> key to exit to the Sofcal Calibrate Menu.

6.2.7. THRESHOLD CALIBRATION

The Threshold Calibration is a series of routines that are built in the 6540 to calibrate each of the three capacitors individually with the 100 M Ω traceable resistor. To execute this process follow the steps below.

NOTE: This operation DOES change the coefficients and voids the previous calibration, both resistance and current. Upon completion the 6540 will have to verified across the operation range.

- Reference Section 4.9.2.1.3.
- Connect the 100 M Ω reference resistor between the SOURCE and INPUT terminals of the instrument.
- Select the SOFCAL CALIBRATE MENU by pressing the <Calibrate> function key when in the Sofcal Menu
- Press the <Ref Vals> function key.
- Press the <Ref Res> function key. 2844275
- Press the <Edit> function key.
- Using the numeric keys enter the value of the reference resistor and its serial number
- New values for variance, standard deviation and sample size criteria for the 1 V and 0.1 V thresholds may be entered using the numeric keypad if required (see Section 4.9.2.3.3)
- Press the <Ok> key to accept/store the new values.
- Press the <Cal Date> function key.
- Press the <Edit> function key to edit/re-enter the new calibration date.
- Press the <Ok> key to accept the new calibration date.
- Press the <PREVIOUS> key to exit back to the Sofcal Calibrate Menu.
- Press the <PREVIOUS> key to exit back to the Sofcal Calibrate Menu (top).
- Press the <Utilites> function key.
- Press the <Thresh Cal.> function key.

Note: Ensure that the 100 M Ω reference resistor is connected. Press the <Calc> key to start the automatic capacitor calibration sequence.

Note: When the calibration sequence is complete the instrument will prompt with the new calibration coefficient in the display window.

- The automated calibration sequence will run each measurement until it has satisfied variance and standard deviation requirements for the sample size of each test.
- If the requirements have not been met within the maximum retries the test is automatically stopped.
- If the test completes fully then acceptable results have been achieved. Press the <Save> key to save the results. This will update all threshold coefficients.

- If the results are not acceptable then, you will need to return to the <Reference> Menu and adjust the test criteria to allow either more retries or a wider standard deviation/variance for the failed test.
- Press the <PREVIOUS> key to exit to the Sofcal Calibrate Menu.

6.2.8. ZERO COEFFICIENT CALIBRATION

The Zero Coefficient Calibration is a stand-alone routine that is built in the 6540 to calibrate the absolute value of the 100 k Ω protection resistor with the 100 M Ω traceable resistor. To execute this process follow the steps below.

- Reference Section 4.9.2.1.4.
- Remove the 100 M Ω reference resistor and replace with a terminal 0 ohm link between SOURCE AND INPUT.
- Select the SOFCAL CALIBRATE MENU by pressing the <Calibrate> function key when in the Sofcal Menu
- Press the <Ref Vals> function key.
- Press the <Ref Zero> function key.
- Press the <Edit> function key.
- Using the numeric keys enter the new value of the reference resistor and its serial number.
- New values for variance, standard deviation and sample size criteria for the zero ohm calibration may be entered using the numeric keypad if required (see Section 4.9.2.3.4).
- Press the <Ok> key to accept/store the new values.
- Press the <Cal Date> function key.
- Press the <Edit> function key to edit/re-enter the new calibration date.
- Press the <Ok> key to accept the new calibration date.
- Press the <PREVIOUS> key to exit back to the Sofcal Calibrate Menu.
- Press the <PREVIOUS> key to exit back to the Sofcal Calibrate Menu (top).
- Press the <Utilites> function key.
- Press the <Zero Cal.> function key.

Note: Ensure that the 0 ohm link is connected. Press the <Calc> key to start the automatic capacitor calibration sequence.

Note: When the calibration sequence is complete the instrument will prompt with the new calibration coefficient in the display window.

- The automated calibration sequence will run each measurement until it has satisfied variance and standard deviation requirements for the sample size of each test.
- If the requirements have not been met within the maximum retries the test is automatically stopped.
- If the test completes fully then acceptable results have been achieved. Press the <Save> key to save the results. This will update the protection resistor coefficient.

- If the results are not acceptable then, you will need to return to the <Reference> Menu and adjust the test criteria to allow either more retries or a wider standard deviation/variance for the failed test.
- Press the <PREVIOUS> key to exit to the Sofcal Calibrate Menu.

6.3. CALIBRATION REPORT

Prepare a tabulated results sheet similar to that shown in Table 6-3, using the data reported by the instrument during the calibration procedure of Section 6.2.

MODEL 6540 Dual Measurement High Resistance Bridge

Serial Number: _____

Variant: _____

Test Voltage (volts)	Coefficient (ppm)	Limits ± (ppm)
1		1000
2		1000
5		1000
10		1000
20		1000
50		1000
100		1000
200		1000
500		1000
1000		1000
-1		1000
-2		1000
-5		1000
-10		1000
-20		1000
-50		1000
-100		1000
-200		1000
-500		1000
-1000		1000

Capacitor pF	Coefficient (ppm)	Limits ± (ppm)
27		200000
270		80000
2700		20000

Threshold (Volts)	Coefficient (ppm)	Limits ± (ppm)
0.1		1000
1.0		1000

Zero Coefficient: _____ Ohms (Limits: 90 000 ohms to 11 000 ohms)

Dated: _____

Calibrated by: _____

Table 6-3: Sample Calibration Report Format

6.4. CALIBRATION THEORY

After each resistance reading the integration time is converted to a resistance. The conversion from time to resistance is achieved using the formula:

$$\text{Resistance} = \frac{V_{\text{test}} \times T_{\text{integration}}}{2 \times C_{\text{integrator}} \times T_{\text{integrator}}} - R_{\text{protection}}$$

Where: Resistance is the value of the unknown resistor

V_{test} is the test voltage from the 6540 source

$T_{\text{integration}}$ is the time for the integration

$C_{\text{integrator}}$ is the value of the integrator capacitor

$T_{\text{integrator}}$ is the threshold of the integrator

$R_{\text{protection}}$ is the value of the protection resistor.

The nominal values of each of the components in the equation are known except for the unknown resistance. The variances from the nominal values are determined during the calibration process using Sofcal utilities. The 6540 system software calls up the nominal value of each component and corrects each by use of the respective calibration coefficient before computing the resistance value.

6.4.1. $R_{\text{protection}}$ COEFFICIENT

The value of the protection resistor is measured by the instrument during calibration using a short circuit connection between the source and input connectors of the 6540 and is stored in the instrument's Non-Volatile memory.

6.4.2. V_{test} COEFFICIENTS

The variance of the test voltage from its nominal value is determined during calibration by selecting each possible output voltage and measuring its absolute value with a precision voltmeter. The variance of the output voltage from its nominal value is computed in Parts Per Million (ppm) and entered into the instrument's Non-Volatile memory either from the front panel or through one of the bus interfaces (RS-232C or GPIB). It should be noted that there are (14) fourteen different coefficients computed, and stored in the instrument, one for each voltage of each polarity.

6.4.3. Cintegrator COEFFICIENTS

The exact value of the reference resistor (used during calibration to compute the capacitor and threshold variances) is entered into the instrument's Non-Volatile memory either from the front panel (see section 4) or through one of the bus interfaces.

The instrument computes the variance of each integration capacitor. A traceable Standard Reference resistor (100 M Ω) is connected between the instrument's source and input terminals. The instrument then takes readings of the Standard Reference resistance until the calibration criteria are met and computes an average resistance value with corrections for the source voltage and the protection resistor. Using the average resistance value and the reference resistance value a number representing the variance of the capacitor from its nominal value is computed. The capacitor coefficient is automatically stored into the instrument's Non-Volatile memory. (see Section 4.9.2.1.2)

6.4.4. Tintegrator COEFFICIENTS

The instrument also computes the variance of the integration thresholds. A known Standard Reference resistor (100 M Ω) is connected between the instrument's source and input terminals. The instrument then takes readings of the Standard Reference resistance until the calibration criteria are met and computes an average value with corrections for the source voltage, the integration capacitor and the protection resistor. The average value and the resistance value are used to compute a number representing the variance of the threshold from its nominal value. The threshold variance is automatically stored in the instrument's Non-Volatile memory. The Tintegrator Coefficient for the 10 V threshold is assumed to be 0. (see Section 4.9.2.1.3)

7. TROUBLE SHOOTING AND MAINTENANCE

7.1. PREVENTATIVE MAINTENANCE

Preventative maintenance consists of cleaning and visual inspection of the instrument. Preventative maintenance performed on a regular basis will prevent instrument breakdown and will improve the reliability of this instrument. The severity of the environment to which the 6540 is subjected determines the frequency of maintenance. A convenient time to perform preventative maintenance is preceding recalibration of the instrument. Do not open the instrument for any of the described maintenance activities as removal the protective covering of the 6540 may cause rather than prevent problems.

The 6540 should be cleaned as often as operating conditions require. Accumulation of dirt in the instrument air filter can cause overheating and component breakdown due to improper airflow. These filters should be vacuumed out to keep a clear airflow. The dress skins also provide protection against dust in the interior of the instrument. Operation without these panels in place necessitates more frequent cleaning. However, it is recommended that you remove the dress skins to allow better access for vacuuming the air filter

Periodically inspect the instrument for general cleanliness.

CAUTION

Avoid the use of chemical cleaning agents that might damage the plastics used in this instrument. In particular, avoid chemicals that contain benzene toluene, xylene or similar solvents.

Periodically check the diagnostics utility in the 6540 and confirm that there are no error conditions displayed.

Routinely run the artifact calibration procedure to ensure the 6540 is operating to full specifications. See Section 6.

If the instrument is not correctly functioning remove the cover and clean out any accumulated dust with a soft brush, at the same time check for discoloured or damaged wiring. Check all screws and hardware for tightness. This should only occur as a corrective measure.

Note: A grounding wrist strap must be used to prevent electro-static discharge to sensitive components whenever the top cover is removed.

7.2. NON VOLATILE MEMORY CHECKSUM

The model 6540 Dual Measurement High Resistance Bridge contains a bank of memory into which certain operating data are written and stored. This memory is non-volatile in that data are kept even when power is removed from the instrument.

The integrity of the data in this memory is checked on power up and on an instrument RESET by comparing a stored checksum value with a calculated value. The two checksum values should agree. Occasionally, the stored checksum value may not agree with the newly calculated value (on RESET or Power Up) due to an operator error in entering new data into the non-volatile (NV) RAM or when the non-volatile (NV) RAM battery is low.

When this occurs the 6540 will display the message "NON-VOLATILE MEMORY FAILURE, Press any key to continue". The 6540 will restore factory-set default values and will calculate a new checksum, then reinitialize all non volatile memory.

7.3. TROUBLESHOOTING

Symptom	Possible Cause
No display	Instrument not plugged into source of AC power. Instrument not powered ON. Power Supply fuse open. Cable between CPU PCB and Display PCB loose. Faulty connector on cable between CPU and Display PCB. Faulty Display PCB. Faulty CPU PCB. Faulty Power Supply PCB.
Display on but no Keyboard response	Keyboard switches locked out by remote controller. Cable between CPU and Display PCB loose. Faulty connector on cable between CPU and Display PCB. Faulty Display PCB.
Display on but only partial Keyboard response	Cable between CPU and Display PCB faulty. Faulty Display PCB.
RS-232C no response	Incorrect baud rate set. Talk/Listen mode not selected. RS-232C cable not connected to instrument properly. Cable from rear panel RS-232C connector to CPU PCB faulty. Faulty CPU PCB.

7.4. ERROR MESSAGES

Display Message	Comment
RAM FAILURE XX	RAM Test Failure in bank XX where XX is in the range 01 through 16.
FAST ADC FAILURE	Interrupt from the ADC has not been generated or has not been recognized
ADC NOT RUNNING	ADC converter not running correctly.
ADC OFFSET X.YZ	Ground (zero volts) input to MUX is out of range or MUX output offset magnitude too large. The measured offset is displayed as X.YZ volts.
ADC GAIN XXXX	The 10 V reference channel is measured and determined to be out of range. The measured unacceptable gain is displayed as XXXX.
ADC RATE XXX KHZ	The ADC interrupt rate is out of range as either too slow or too fast. The measured unacceptable rate is displayed as XXX KHZ.
+ 5 Volts X.XX	+ 5 V analogue power supply out of limits; measured X.XX V.
- 5 Volts X.XX	- 5 V analogue power supply out of limits; measured X.XX V.
+ 15 Volts X.XX	+ 15 V analogue power supply out of limits; measured X.XX V.
- 15 Volts X.XX	- 15 V analogue power supply out of limits; measured X > XX V.
PRECHARGE X.XX	Precharge Voltage out of limits; measured X.XX V.
HV MON X.XX	High Voltage monitoring point out of limits; measured X.XX V.
10 V REF X.XX	10 volt Reference point out of limits; measured X.XX V.
RAMP X.XX	Ramp Reference point out of limits; measured X.XX V.
Electrometer OFF	Ramp is not moving or integration time is too long.
Integration < 3ms	Ramp is moving to fast or integration time is too short.

Display Message

Comment

+ 5 Volts X.X	+ 5 V digital power supply out of limits; measured X.X V.
- 5 Volts X.X	- 5 V digital power supply out of limits; measured X.X V.
+ 15 Volts X.X	+ 15 V digital power supply out of limits; measured X.X V.
- 15 Volts X.X	- 15 V digital power supply out of limits; measured X.X V.

8. APPENDICES

8.1. GENERAL SPECIFICATIONS

GENERAL SPECIFICATIONS						
Voltages				Statistics (Detail and Summary)		
1, 2, 5, 10, 20, 50, 100, 200, 500, 1000 V _{DC}				Min, Max, Avg, Std Dev, # Samples		
Bridge Mode Connectors (Rs/Rx)			Direct Mode Connectors			
Source (+)	Miniature High Voltage MHV (F)			+	Miniature High Voltage MHV (F)	
Input (-)	3 lug Triax (F)			-	3 lug Triax (F)	
Display Resolution	4 to 8 Digits (Selectable)			Input Impedance	100 kΩ (Bridge & Direct)	
Measurement time	5ms to > 1000 seconds			# User Profiles	36 Programmable	
Input Voltage (User Selectable)				Power		
50 or 60 Hz (± 5%)		100, 120, 220, 240 VAC (± 10 %)		50 VA		
Rear Interfaces						
IEEE 488.2		RS232C		Interlock (Safety)		Ext Trig
Temperature Environment						
Stability		Operating			Storage	
1°C		15 °C to 30 °C	59 °F to 86 °F		-30 °C to 70 °C	-22 °F to 158 °F
Humidity (Non-Condensing)						
Operating		20 % to 50 % RH		Storage		15 % to 80 % RH
Dimensions		(H)	(W)	(L)	Weight	
Metric (mm)		133.4	442	523	Instrument	25 lbs 11.4 kg
US (Inches)		5.25	17.4	20.6	Shipping	40 lbs 18.2 kg

Table 8-1: General Specifications

Note: Add 11mm (0.4 in.) to height for bench top feet.

8.2. RESISTANCE MEASUREMENT SPECIFICATIONS

Note: The uncertainties listed in Table 8-2 are applicable after a four-hour warm-up period when using the autoranging mode of operation and when the current is no less than one picoampere through the unknown resistor. Many types of high value resistors can be difficult to measure accurately with the 6540 in autoreverse mode because their actual resistance value changes slowly for a period of time after a polarity reversal. They can however be measured to the full 6540 accuracy by allowing sufficient settling time between polarity reversals (soak time). This is done under manual control or through adjusting the 6540 parameters. The accuracy is traceable to the International System of Units (SI) through NRCC (Canada) or other National Metrology Institutes.

Bridge Mode

Rs	Max Resolution	Voltage Range ²	12 Month Ratio Accuracy ³		
			1:1	10:1	100:1
100 kΩ ¹	0.00001 kΩ	1 V	7	7	20
1 MΩ	0.0000001 MΩ	1 V	7	7	20
10 MΩ	0.000001 MΩ	1 V to 10 V	6	6	20
100 MΩ	0.00001 MΩ	1 V to 100 V	3.5	6	20
1 GΩ	0.0000001 GΩ	1 V to 1000 V	5	7	20
10 GΩ	0.000001 GΩ	10 V to 1000 V	7	10	30
100 GΩ	0.00001 GΩ	100 V to 1000 V	10	15	70
1 TΩ	0.0000001 TΩ	1000 V	20	70	120
10 TΩ	0.000001 TΩ	1000 V	70	100	
100 TΩ	0.00001 TΩ	1000 V	180		
1 PΩ	0.0000001 PΩ	1000 V	800		
10 PΩ	0.000001 PΩ	1000 V	2000		

1 – 100 kΩ is minimum measurement

2 – Selectable from available voltages

3 – Ratios do not include Rs Uncertainty and are specified ($\pm \mu\Omega/\Omega$) at k=2 (95% CL)

Table 8-2: Bridge Mode Resistance Measurement Uncertainty

Direct Measurement Mode

Range ¹	Full Scale	Max Resolution	Voltage Range ²	12 Month Accuracy ³	
				Relative	Absolute
100 kΩ	200 kΩ	0.00001 kΩ	1 V	100	120
1 MΩ	2 MΩ	0.0000001 MΩ	1 V	50	60
10 MΩ	20 MΩ	0.000001 MΩ	1 V to 10 V	50	60
100 MΩ	200 MΩ	0.00001 MΩ	1 V to 100 V	50	60
1 GΩ	2 GΩ	0.0000001 GΩ	1 V to 1000 V	50	60
10 GΩ	20 GΩ	0.000001 GΩ	10 V to 1000 V	100	140
100 GΩ	200 GΩ	0.00001 GΩ	100 V to 1000 V	100	150
1 TΩ	2 TΩ	0.0000001 TΩ	1000 V	500	575
10 TΩ	20 TΩ	0.000001 TΩ	1000 V	1000	1150
100 TΩ	200 TΩ	0.00001 TΩ	1000 V	1500	2000
1 PΩ	2 PΩ	0.0000001 PΩ	1000 V	10000	15000
10 PΩ	20 PΩ	0.000001 PΩ	1000 V	100000	150000

1 - Minimum resistance measurement is 20% of Range for selected range. 100 kΩ is minimum measurement

2 – Selectable from available voltages

3 – Accuracy is specified ($\pm \mu\Omega/\Omega$) at $k=2$ (95% CL). Absolute accuracy includes Guildline Laboratory Environmental parameters and 17025 Accredited Uncertainties

Table 8-3: Direct Resistance Measurement Uncertainty

8.3. PICOAMMETER MEASUREMENT SPECIFICATIONS

Note: The uncertainties listed in Table 8-3 are applicable after a one-hour warm-up period when using the autoranging mode of operation. The accuracy is traceable to the International System of Units (SI) through NRCC (Canada) or other National Metrology Institutes.

12 Month Absolute Specifications (\pm %) 23 °C \pm 5 °C								
Range	20 μ A	2 μ A	200 nA	20 nA	2 nA	20 pA	200 pA	2 pA
Accuracy	\pm 0.1 %	\pm 0.1 %	\pm 0.2 %	\pm 0.2 %	\pm 0.2 %	\pm 0.2 %	\pm 5 %	\pm 20 %

Table 8-4: Current Measurement Uncertainty (All Models)

8.4. RESOLUTION

When the Model 6540 is used with short integration time periods, the measurement resolution is limited by the quantization error in the time measuring circuit (plus or minus one clock period). When the quantization error is not significant, the display resolution is truncated at a value commensurate with the short-term measurement stability. The measurement display resolution can be set by the user using the **Set Up Menu** option. The default resolution is fixed at 6 digits. If the **<Auto res>** option is selected then the instrument will set the resolution based on Table 8-4.

Integrating Capacitor	Display Resolution (Digits) Integration Time				
	5.4 mSec	54 mSec	540 mSec	5.4 Sec	Up To 20000 Sec
pF					
27	5	5	6	6	5
270	5	6	7	7	7
2700	6	7	7	7	7

Table 8-5: Measurement Resolutions (Digits)

Note: The measurements can be performed with reduced accuracy for integration times less than 5.4 mSec down to 3 mSec.

8.5. SYSTEM PARAMETER

The table below describes the valid 6540 measurement setups along with the default parameters defined for each resistance/voltage range in auto-reverse mode. These parameters can be accessed and modified in the System parameter section of the 6540. It should be noted that modification of these parameters from the same in which the 6540 was calibrated invalidates the calibration. The 6540 comes from the factory calibrated to these default parameters.

Note:

- 1 The dark grey areas are the parameters and range selection that is used by the auto ranging function of the 6540. These represent the optimal measurement parameters for both Direct Measurement and Bridge Modes.
- 2 The light grey areas are areas in which the 6540 will measure in Direct Measurement mode to full rated specifications. These alternate settings provide a method for voltage coefficient testing. Bridge Mode is also valid in these areas.
- 3 The white areas in the table are measurements the 6540 can make but are not specified or calibrated for Direct Measurement and are only valid for Bridge Mode.

6540-B Model

Range	Nominal	Test V	Cap.	Thresh.	Ramp	Auto?	Count	Size
2M to 20M	10M	1	2700	10	0.54	*	17	20
	10M	2	2700	10	0.27		17	20
	10M	5	2700	10	0.108		25	30
	10M	10	2700	10	0.054		38	45
	10M	20	2700	10	0.027		58	65
	10M	50	2700	10	0.0108		72	80
	10M	100	2700	10	0.0054		90	100
20M to 200M	100M	1	2700	10	5.4	*	6	8
	100M	2	2700	10	2.7		6	8
	100M	5	2700	10	1.08		6	8
	100M	10	2700	10	0.54		6	8
	100M	20	2700	10	0.27		17	20
	100M	50	2700	10	0.108		25	30
	100M	100	2700	10	0.054		38	45
	100M	200	2700	10	0.027		58	65
	100M	500	2700	10	0.0108		72	80
	100M	1000	2700	10	0.0054		90	100

200M to 2G	1G	1	2700	1	5.4		8	12
	1G	2	2700	1	2.7		8	12
	1G	5	2700	10	10.8		8	12
	1G	10	2700	10	5.4	*	8	12
	1G	20	2700	10	2.7		8	12
	1G	50	2700	10	1.08		8	12
	1G	100	2700	10	0.54		8	12
	1G	200	2700	10	0.27		17	20
	1G	500	2700	10	0.108		25	30
	1G	1000	2700	10	0.054		38	45
2G to 20G	10G	1	2700	0.1	5.4		8	12
	10G	2	2700	0.1	2.7		8	12
	10G	5	2700	1	10.8		8	12
	10G	10	2700	1	5.4		8	12
	10G	20	2700	1	2.7		8	12
	10G	50	2700	10	10.8		8	12
	10G	100	2700	10	5.4	*	8	12
	10G	200	2700	10	2.7		8	12
	10G	500	2700	10	1.08		8	12
	10G	1000	2700	10	0.54		8	12
20G to 200G	100G	1	270	0.1	5.4		12	20
	100G	2	270	0.1	2.7		12	20
	100G	5	2700	0.1	10.8		12	20
	100G	10	2700	0.1	5.4		12	20
	100G	20	2700	0.1	2.7		12	20
	100G	50	2700	1	10.8		12	20
	100G	100	2700	1	5.4		12	20
	100G	200	2700	1	2.7		12	20
	100G	500	2700	10	10.8		12	20
	100G	1000	2700	10	5.4	*	12	20
200G to 2T	1T	1	27	0.1	5.4		12	20
	1T	2	27	0.1	2.7		12	20
	1T	5	270	0.1	10.8		12	20
	1T	10	270	0.1	5.4		12	20
	1T	20	270	0.1	2.7		12	20
	1T	50	2700	0.1	10.8		12	20
	1T	100	2700	0.1	5.4		12	20
	1T	200	2700	0.1	2.7		12	20
	1T	500	2700	1	10.8		12	20
	1T	1000	2700	1	5.4	*	12	20

2T to 20T	10T	5	27	0.1	10.8		20	50
	10T	10	27	0.1	5.4		20	50
	10T	20	27	0.1	2.7		20	50
	10T	50	270	0.1	10.8		20	50
	10T	100	270	0.1	5.4		20	50
	10T	200	270	0.1	2.7		20	50
	10T	500	2700	0.1	10.8		20	50
	10T	1000	2700	0.1	5.4	*	20	50
20T to 200T	100T	1000	270	0.1	54	*	20	50

6540-XR Model

Range	Nominal	Test V	Cap.	Thresh.	Ramp	Auto?	Count	Size
90k to 200k	100k	1	2700	10	0.0054	*	90	100
200k to 2M	1M	1	2700	10	0.054	*	45	50
	1M	2	2700	10	0.027		58	65
	1M	5	2700	10	0.0108		72	80
	1M	10	2700	10	0.0054		90	100
2M to 20M	10M	1	2700	10	0.54	*	17	20
	10M	2	2700	10	0.27		17	20
	10M	5	2700	10	0.108		25	30
	10M	10	2700	10	0.054		38	45
	10M	20	2700	10	0.027		58	65
	10M	50	2700	10	0.0108		72	80
	10M	100	2700	10	0.0054		90	100
20M to 200M	100M	1	2700	10	5.4	*	6	8
	100M	2	2700	10	2.7		6	8
	100M	5	2700	10	1.08		6	8
	100M	10	2700	10	0.54		6	8
	100M	20	2700	10	0.27		17	20
	100M	50	2700	10	0.108		25	30
	100M	100	2700	10	0.054		38	45
	100M	200	2700	10	0.027		58	65
	100M	500	2700	10	0.0108		72	80
	100M	1000	2700	10	0.0054		90	100

200M to 2G	1G	1	2700	1	5.4		8	12
	1G	2	2700	1	2.7		8	12
	1G	5	2700	10	10.8		8	12
	1G	10	2700	10	5.4	*	8	12
	1G	20	2700	10	2.7		8	12
	1G	50	2700	10	1.08		8	12
	1G	100	2700	10	0.54		8	12
	1G	200	2700	10	0.27		17	20
	1G	500	2700	10	0.108		25	30
	1G	1000	2700	10	0.054		38	45
2G to 20G	10G	1	2700	0.1	5.4		8	12
	10G	2	2700	0.1	2.7		8	12
	10G	5	2700	1	10.8		8	12
	10G	10	2700	1	5.4		8	12
	10G	20	2700	1	2.7		8	12
	10G	50	2700	10	10.8		8	12
	10G	100	2700	10	5.4	*	8	12
	10G	200	2700	10	2.7		8	12
	10G	500	2700	10	1.08		8	12
	10G	1000	2700	10	0.54		8	12
20G to 200G	100G	1	270	0.1	5.4		12	20
	100G	2	270	0.1	2.7		12	20
	100G	5	2700	0.1	10.8		12	20
	100G	10	2700	0.1	5.4		12	20
	100G	20	2700	0.1	2.7		12	20
	100G	50	2700	1	10.8		12	20
	100G	100	2700	1	5.4		12	20
	100G	200	2700	1	2.7		12	20
	100G	500	2700	10	10.8		12	20
	100G	1000	2700	10	5.4	*	12	20
200G to 2T	1T	1	27	0.1	5.4		12	20
	1T	2	27	0.1	2.7		12	20
	1T	5	270	0.1	10.8		12	20
	1T	10	270	0.1	5.4		12	20
	1T	20	270	0.1	2.7		12	20
	1T	50	2700	0.1	10.8		12	20
	1T	100	2700	0.1	5.4		12	20
	1T	200	2700	0.1	2.7		12	20
	1T	500	2700	1	10.8		12	20
	1T	1000	2700	1	5.4	*	12	20

2T to 20T	10T	5	27	0.1	10.8		20	50
	10T	10	27	0.1	5.4		20	50
	10T	20	27	0.1	2.7		20	50
	10T	50	270	0.1	10.8		20	50
	10T	100	270	0.1	5.4		20	50
	10T	200	270	0.1	2.7		20	50
	10T	500	2700	0.1	10.8		20	50
	10T	1000	2700	0.1	5.4	*	20	50
20T to 200T	100T	50	27	0.1	10.8		20	50
	100T	100	27	0.1	5.4		20	50
	100T	200	27	0.1	2.7		20	50
	100T	500	270	0.1	10.8		20	50
	100T	1000	270	0.1	5.4	*	20	50
200T to 2P	1P	500	27	0.1	5.4		20	50
	1P	1000	27	0.1	5.4	*	20	50
2P to 20P	10P	1000	27	0.1	5.4	*	20	50

Table 8-6: Default System parameter

8.6. SAMPLE BUS CONTROL PROGRAM

The following is a brief note on how to configure a National Instruments GPIB-PC controller card when used with the 6540. A program outline is provided that collects data using the National Instruments GPIB-PC interface.

Assuming that the National Instrument driver has been installed with all the default naming, the device name for ADDRESS 4 will be "DEV4", and could be used to control the 6540.

The "DEV4" should be configured as follows:

- Default device name: DEV4
- GPIB address (fixed): 4
- Secondary address: none
- Timeout setting: 3 seconds
- Serial poll timeout: 3 seconds
- Terminate read on EOS: YES
- Set EOI with EOS on write: YES
- Type of compare on EOS: 7 bit
- EOS byte: 0A hex
- Send EOI at end of writes: YES
- Enable repeat addressing: YES

- Programming Note 1 : BASIC

Sample Bus Control Program Using Basic And National Instruments GPIB-PC Controller

```
100 REM BASIC Example Program - for Guildline Model 6540 Dual Measurement
    High Resistance Bridge
110 REM 6540
120 REM
130 REM You MUST merge this code with DECL.BAS.
140 REM
150 REM Assign a unique identifier to device and
160 REM store in variable DEV%.
170 REM
180   BDNAME$ = "DEV4"
190   CALL IBFIND (BDNAME$, DEV%)
200 REM
210 REM Check for error on IBFIND call.
220 REM
230   IF DEV% < 0 THEN GOSUB 2000
240 REM
250 REM Clear the device.
260   CALL IBCLR (DEV%)
270 REM
280 REM Check for an error on each GPIB call to be

290 REM safe.
300 REM
320   IF IBSTA% < 0 THEN GOSUB 3000
330 REM
330 REM Tell the 6540 Dual Measurement High Resistance Bridge to measure
    resistance
340 REM
350   WRT$ = "MEAS ON"
360   CALL IBWRT (DEV%,WRT$)
370   IF IBSTA% < 0 THEN GOSUB 3000
380 REM
390 REM Loop on reading the status byte until
400 REM the 6540 says that the reading is complete
410 REM Check that the 6540 is still measuring.
420 REM If not measuring then an error has occurred
430   WRT$ = "MEAS?"
440   CALL IBWRT (DEV%,WRT$)
450   IF IBSTA% < 0 THEN GOSUB 3000
460   RD$ = SPACE$(48)
470   CALL IBRD (DEV%,RD$)
480   IF IBSTA% < 0 THEN GOSUB 3000
490   IF RD$ <> "On" THEN GOTO 4000
500 REM Prevent timeout on Voltage Source
510   WRT$ = "CONF:TEST:VOLT CONT"
520   CALL IBWRT (DEV%,WRT$)
530   IF IBSTA% < 0 THEN GOSUB 3000
540 REM
550 REM Now test the status byte (STB).
```



```
560 REM If STB has bit 2 set then the 6540 Dual Measurement High
    Resistance Bridge
570 REM has finished its reading otherwise
580 REM loop around
590 REM
600   WRT$="*STB?" : CALL IBWRT (DEV%,WRT$)
610   IF IBSTA% < 0 THEN GOSUB 3000
620   RD$ = SPACE$(48) : CALL IBRD (DEV%,RD$)
630   IF IBSTA% < 0 THEN GOSUB 3000
640   IF VAL(RD$) AND &H02 THEN GOTO 700
650   GOTO 430
660 REM
670 REM Ask the 6540 Dual Measurement High Resistance Bridge to give us
    the next
680 REM measurement
690 REM
660   WRT$ = "READ:RES?" : CALL IBWRT (DEV%,WRT$)
700   IF IBSTA% < 0 THEN GOSUB 3000
710   RD$ = SPACE$(48) : CALL IBRD (DEV%,RD$)
720   IF IBSTA% < 0 THEN GOSUB 3000
730 REM
740 REM Print out the reading and loop around to catch
750 REM the next reading
760 REM
770   PRINT RD$
780   GOTO 430
2000 REM A routine at this location would notify
2010 REM you that the IBFIND call failed, and
2020 REM refer you to the handler software
2030 REM configuration procedures.
2040   PRINT "IBFIND ERROR" : RETURN
3000 REM An error checking routine at this
3010 REM location would, among other things,
3020 REM check IBERR to determine the exact
3030 REM cause of the error condition and then
3040 REM take action appropriate to the
3050 REM application. For errors during data
3060 REM transfers, IBCNT may be examined to
3070 REM determine the actual number of bytes
3080 REM transferred.
3090   PRINT "GPIB ERROR" : RETURN
4000 REM An error routine to tell you that the measurement
4010 REM terminated prematurely
4020   PRINT "ERROR, TEST TERMINATED PREMATURELY."
4030 REM
5000   END
```

8.7. MEASUREMENT TECHNIQUE

8.7.1. LARGE VALUE RESISTOR MEASUREMENT TECHNIQUE

The measurement of very large value resistors presents special challenges for the operator. The measurement is often rendered meaningless unless certain precautions are taken.

8.7.2. ENVIRONMENT

The test equipment and the test sample should be located in a clean dry area where the temperature is relatively constant near 23°C. The air humidity should be between 20 %rH and 40 % rH. Ionized air and ionizing radiation should not be present in the test area.

8.7.3. SAMPLE PREPARATION

It is very important to prepare the test sample properly so that unwanted parallel leakage paths are reduced as much as possible. The condition of the insulation surface between the sample terminals is very critical since this usually forms a significant source of electrical leakage. The surface must be dry and free of conductive salts or other deposits.

8.7.4. TEST LEAD ROUTING

Although it is good general practice to use shielded test leads (shielded wires with the shields connected to ground) it is especially important with higher value test resistors. Shielded test leads shunt unwanted leakage current away from the electrometer circuit.

8.7.5. CAPACITIVE TEST SAMPLES

Test samples that store electrical charges and have long time constants can be difficult to measure using the autoreverse feature of the 6540 Dual Measurement High Resistance Bridge. You can adjust the autoreverse parameters or, deactivate autoreverse until a stable resistance reading is displayed with one test voltage polarity and then manually reverse the polarity. The reading from both polarities should be recorded and an average computed.

The true resistance of the sample is the numerical average calculated from the two readings taken. This technique allows the sample sufficient time to be measured properly.

8.8. OTHER FEATURES

- * Mounting: Bench top with extra flanges provided separately for 19-inch rack mounting.
- * Input Connector: Front panel with rear panel access optional on request.
- * Power Selection Switch: On rear panel.
- * IEEE488.2 Connector: On rear panel.
- * RS232 Connector: On rear panel.

8.9. ACCESSORY EQUIPMENT

8.9.1. Surface/Volume Resistivity Test Fixture Model 65221

This optional accessory allows the 6540 user to make direct measurement of volume resistivity up to $10^{18}\Omega\text{-cm}$ (on samples 1 mm thick) and surface resistivity up to $10^{17}\Omega/\text{square}$, in accordance with ASTM procedures. A Keithley model 8009 test fixture is supplied with all the necessary interconnect cables for the 6540. A simple series of keystrokes on the 6540 front panel controls, starts the measurement process.



Resistivity Fixture Device Data

Operating Temperature: $-30\text{ }^{\circ}\text{C}$ to $+85\text{ }^{\circ}\text{C}$,

Operating Humidity: 65% R.H. (up to $35\text{ }^{\circ}\text{C}$, derate 3% R.H./ $^{\circ}\text{C}$ above $35\text{ }^{\circ}\text{C}$.)

Storage Temperature: $-25\text{ }^{\circ}\text{C}$ to $+85\text{ }^{\circ}\text{C}$.

Dimensions: 108mm high \times 165mm wide \times 140mm deep (4 1/4 in \times 6 1/2 in \times 5 1/2 in).

Weight: 1.45kg (3.19 lbs).

8.9.2. Calibration Resistors

Precision resistors are available (see Table 8-5) for calibrating the 6540. Each is supplied in a shielded enclosure with two male type N connectors spaced to allow connection to the 6540. To meet the accuracy of the specification in Table 8-2 and Table 8-3, a precision 100 M Ω resistor is recommended for calibration of error coefficients.

Other Calibration Resistors are available in ascending decades from 100 G Ω to 100 T Ω as well as special values on request. These precision resistors are typically used as check standards or transfer standards.

Note: The 6540 will accept only a resistor of approximately 100 M Ω with an uncertainty better than ± 50 ppm for setting the capacitor and threshold error coefficients.

Model	Nominal Resistance Value (Ohms)	Nominal Initial Tolerance (\pm ppm) (Note 1)	Calibration Uncertainty @23°C \pm °C (\pm ppm) (Note 2)	Stability 12 Months (\pm ppm)	Temperature Coefficient 18-28°C (ppm/°C)	Voltage Coefficient (ppm/volt) (Note 3)
65224/0	0	n/a	n/a	n/a	n/a	n/a
9336/10M	10 M	25	15	10	<5	<0.1
9336/100M	100 M	50	<25	25	<5	<0.5
9336/1G	1 G	100	<80	35	<6	<0.5
9336/10G	10 G	200	<100	100	<25	<1
9336/100G	100 G	500	<500	200	<250	<1
9337/1T	1 T	1000	<1000	500	<300	<2
9337/10T	10 T	3000	<4500	750	<500	<2
9337/100T	100 T	5000	<5500	1000	<800	<2
9337/1P	1 P	20000	<10000	2000	<1000	<2
9337/10P	10 P	100000	<50000	5000	<10000	<2

Table 8-7: Calibration Resistors

Note 1: Nominal Initial Tolerance is the maximum variation of resistance mean value as adjusted initially at point of sale.

Note 2: Calibrated at 23°C, referred to the unit of resistance as maintained by National Research Council (NRCC) or another NMI and expressed as a total uncertainty with a coverage factor of k=2.

Note 3: Maximum Voltage Rating: 1000 DC V.

Note 4: The **100 MΩ** resistor is **strongly recommended** to maintain a total uncertainty ratio of 4:1 for the 6540.

8.9.3. Small Shielded Enclosure

The model 65223 Small Enclosure provides a stable shielded environment for measuring high resistances and the leakage resistance of capacitors. The sample capacitor should be connected between the "Source" and "C" terminals. This inserts a 10 MΩ resistor in series with the Capacitor to limit inrush currents.

CAUTION

Hazardous voltages may be present at the SOURCE terminal. Ensure that the 6540 source is turned off before opening the 65223 cover.

Inside dimensions: 138 × 112 × 60 (mm)
 5.375 × 4.375 × 2.375 (ins)

8.9.4. Large Shielded Enclosure

The model 65222 Large Enclosure provides a stable shielded environment for measuring high resistances.

CAUTION

Hazardous voltages may be present at the SOURCE terminal. Ensure that the 6540 source is turned off before opening the 65222 cover. The box of the enclosure should always be connected to the ground lug on the rear panel of the 6540.

Inside dimensions: 342 × 228 × 152 (mm)
 13.5 × 9.0 × 6.0 (ins)

8.9.5. Lead Set Model 65225

The 6540 includes two cables that have a standard BNC End (connects to 6540 Source Input) to a Male "N" connector which is the standard input for the Guildline 9336 and 9337 Source (Female "N" Connection. The 6540 standard cable set also includes two cables with a Triax End (Connects to 6540 Input) to Male "N" type cable which is the standard input for the Guildline 9336 and 9337 "Output" connections.

The 65225 lead set includes the additional cables, connectors and adaptors.

Qty	Part Number	Description
2	30053-02-21	1.8 m coax cable - MHV M to Type N,F
2	30054-02-21	1.8 m triax cable – M to Type N F
1	30055-01-21	1.8 m coax cable – MHV M both ends
1	30046-01-21	1.8 m cable – MHV M to Plug
1	054-20504	alligator clip set
1	997-09223	0.9 m cable, triax M to alligator
1	997-09224	0.9 m cable, Triax M to Triax M
1	003-23237	adapter, Triax F to Triax F

8.9.6. Calibration Kit Model 65226

This kit contains the following items:

- Two 1 meter (39-inch) extension cables fitted with a type N female connector on one end and mating coaxial connectors on the other end for connection to the 6540 front panel Source and Input connectors.
- Type N connector to binding post adapter.
- One Zero Ohm link Model 65224
- One Precision resistor Model 9336/100M

8.9.7. Zero Link Model 65224

This option contains a cable with an internal zero Ohm link used in the calibration of the 6540.

8.9.8. IEEE Interface Accessories

This option allows the connection of the 6540 to a Personal Computer or Laptop for software and remote control.

Interface	Supported OS	Description
IEEE PCI	Win 95 to Win XP	PCI IEEE-488.2 Interface Card (for PC only)
IEEE USB	Win 2K to Win 7	USB IEEE-488.2 Interface (for Laptop/PC) *** Recommended
IEEE PCMCIA	Win 95 to Win XP	PCMCIA IEEE-488.2 Interface Card (for Laptop only)
IEEE Cable 1M	N/A	1 Meter, Double Shielded IEEE 488.2 Interface Cable
IEEE Cable 2M	N/A	2 Meter, Double Shielded IEEE 488.2 Interface Cable *** Recommended
IEEE Cable PCMCIA	N/A	1 Meter PCMCIA to IEEE Cable

Table 8-8: IEEE Interfaces

8.9.9. 6564 High Resistance Scanner

The 6564 High Resistance scanner is a high isolation switch for TΩ measurements providing isolation of over 100 PΩ. The 6564 when used with SCPI commands, vastly increases the measurement throughput, and simplifies bridge transfers through automation. The 6564 can be provided in 8 or 16 channel configurations.